

# Number 1

Name \_\_\_\_\_

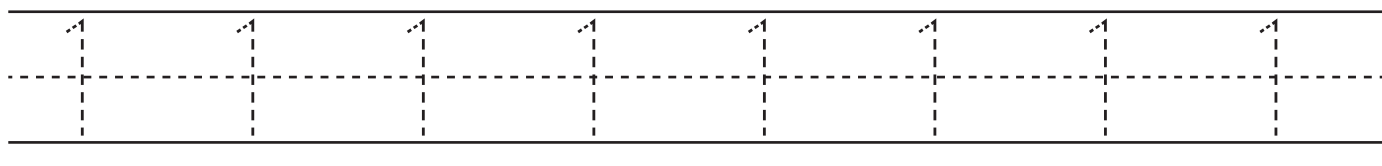

Color 1 star.

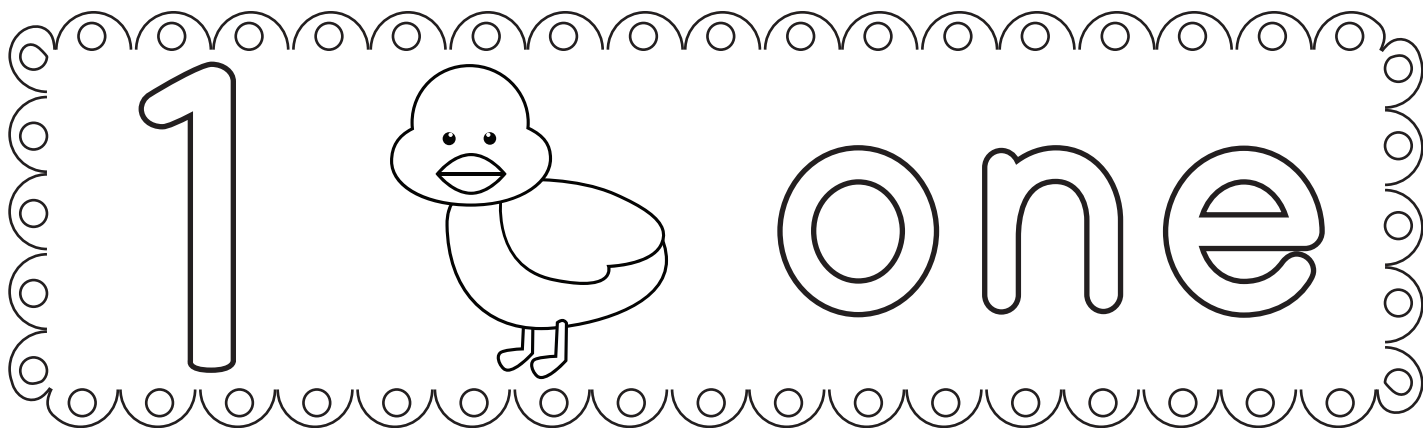
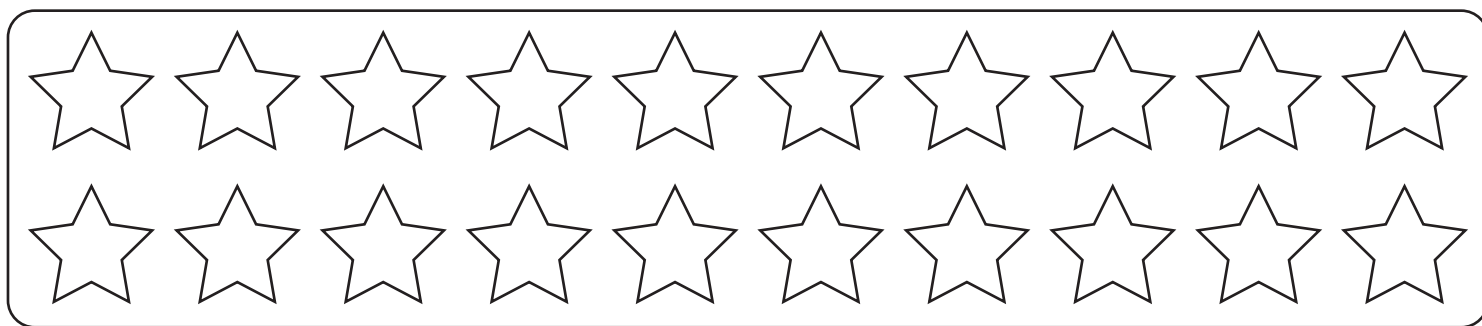

Circle the square with 1 image.

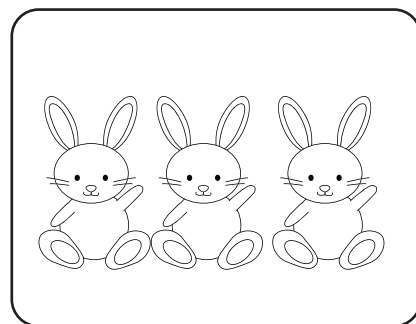
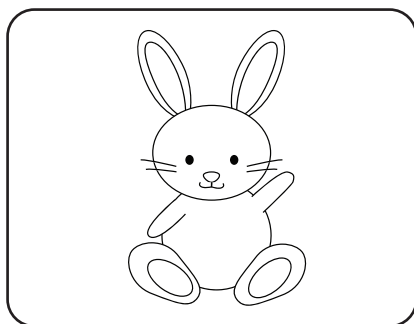
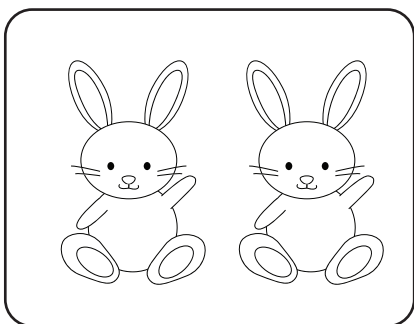

# Number 2

Name \_\_\_\_\_

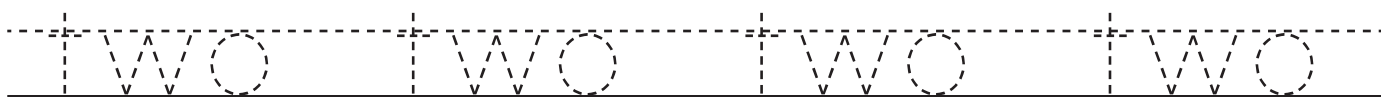
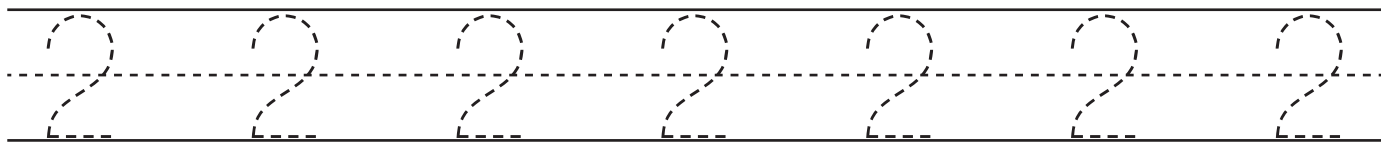
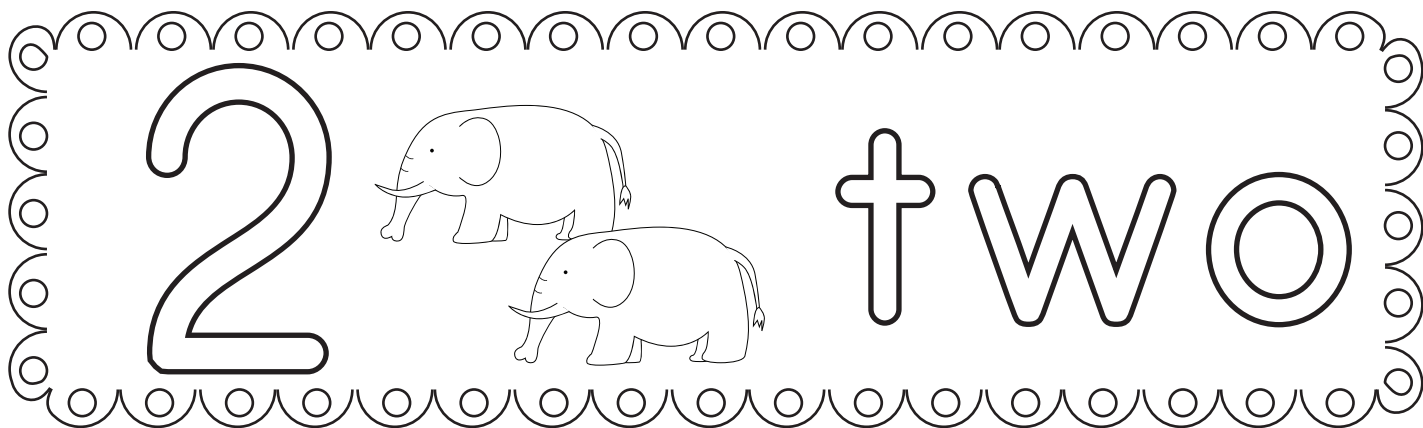

Color 2 stars.

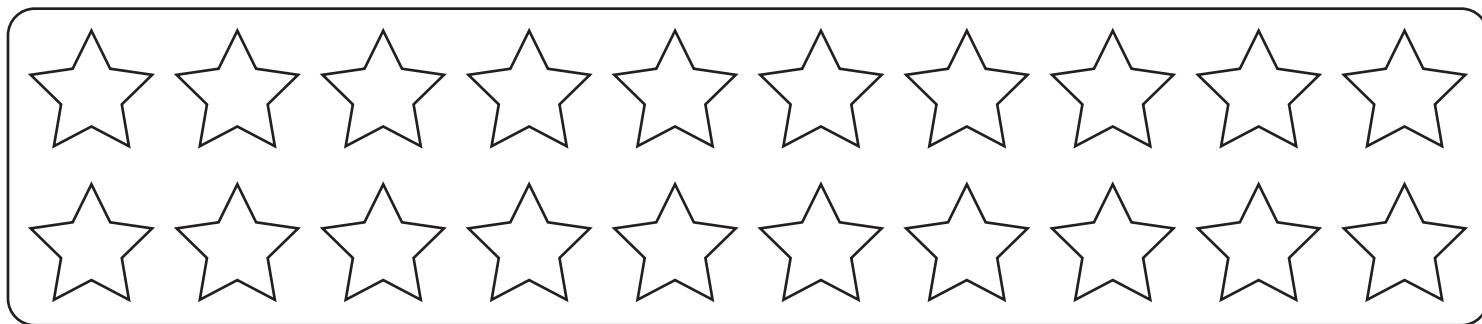

Circle the square with 2 images.

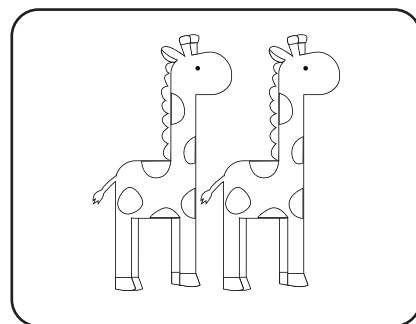
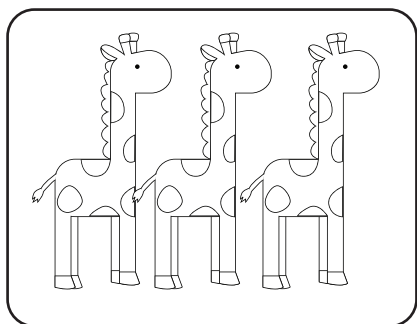
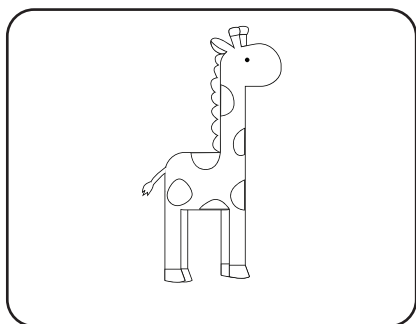

# Number 3

Name \_\_\_\_\_

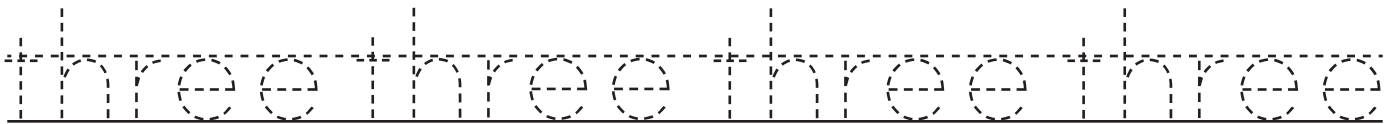
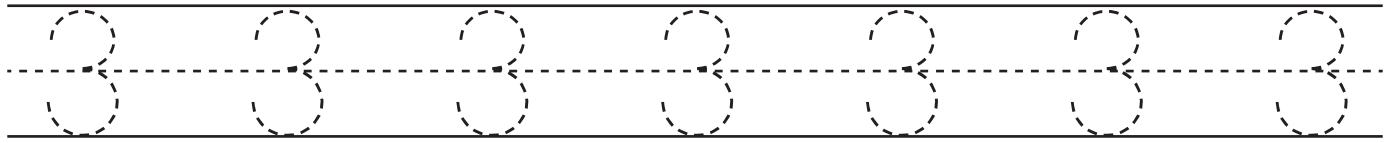
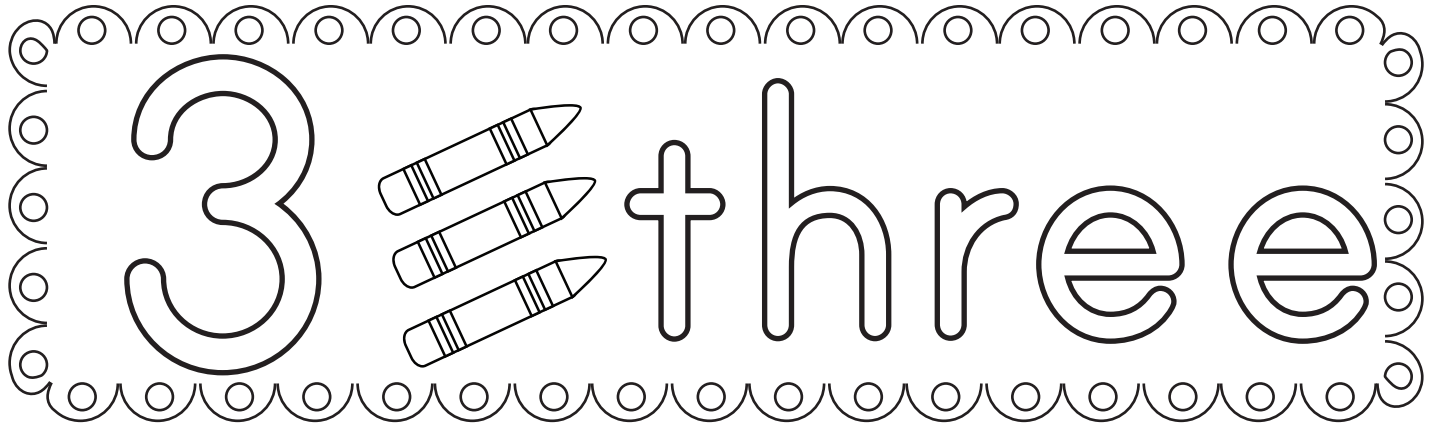

Color 3 stars.

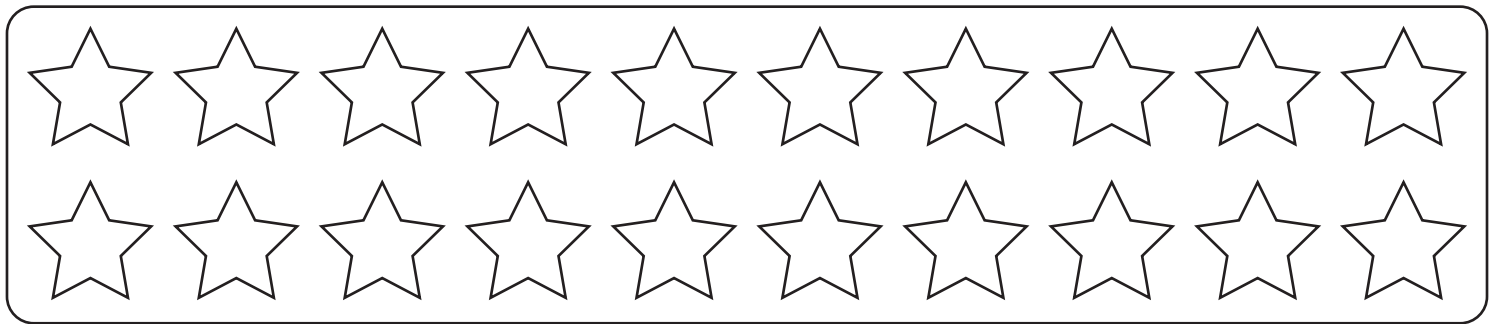

Circle the square with 3 images.

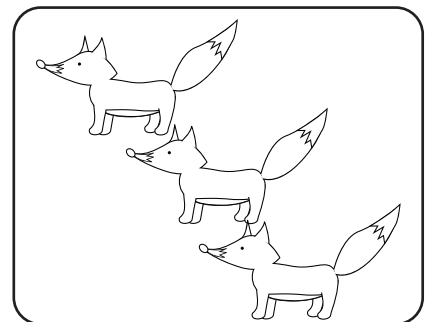
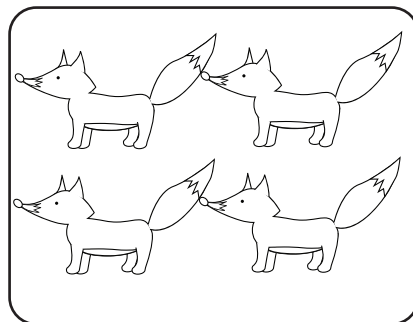
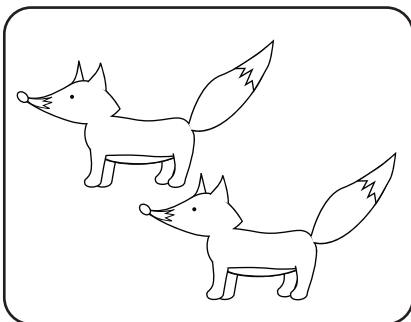

# Number 4

Name \_\_\_\_\_

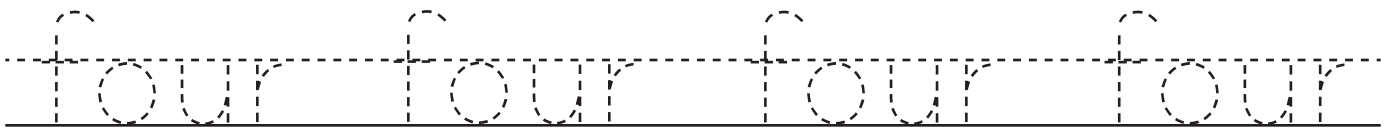
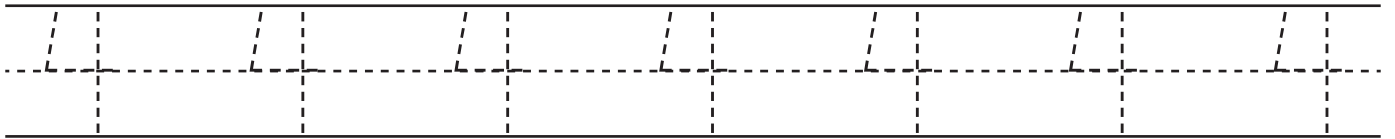
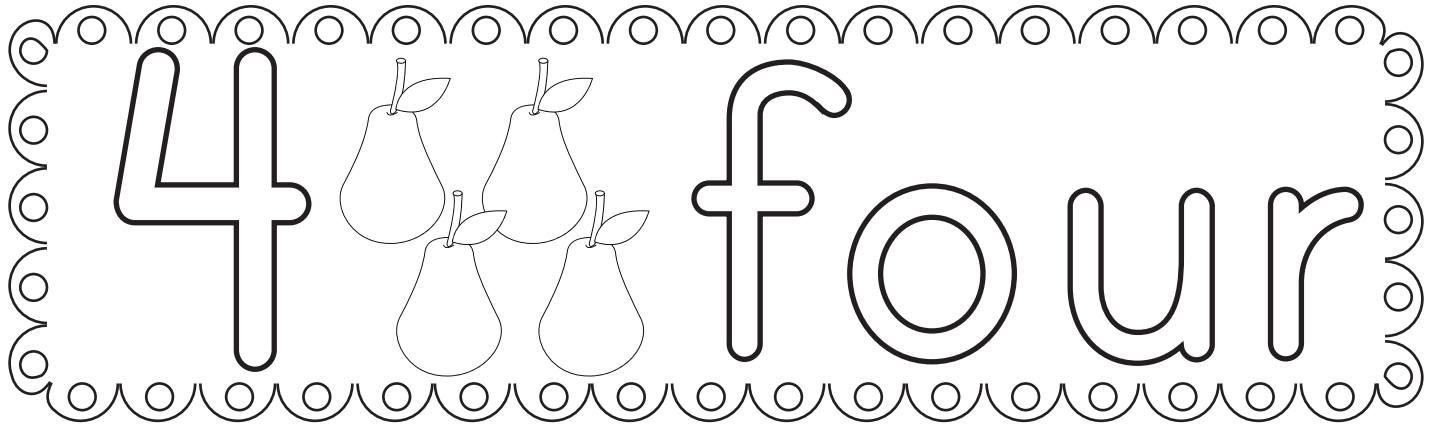

Color 4 stars.

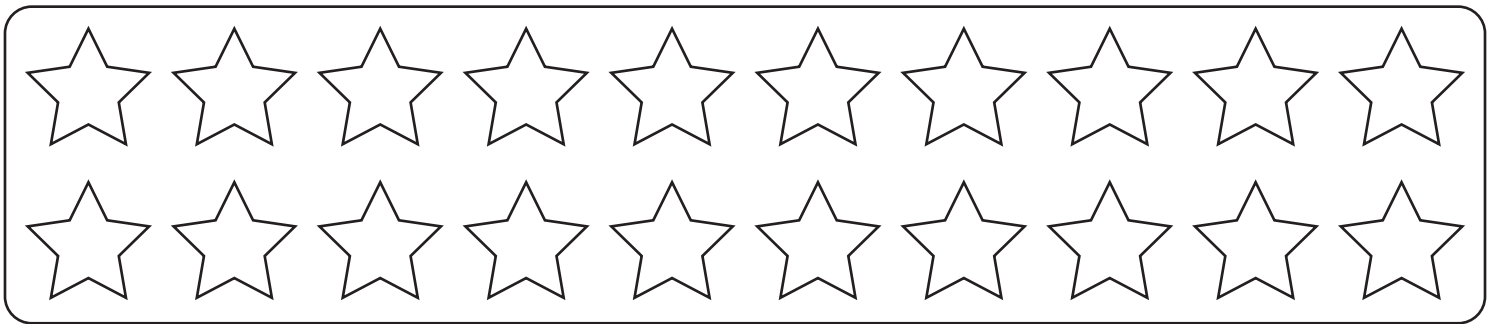

Circle the square with 4 images.

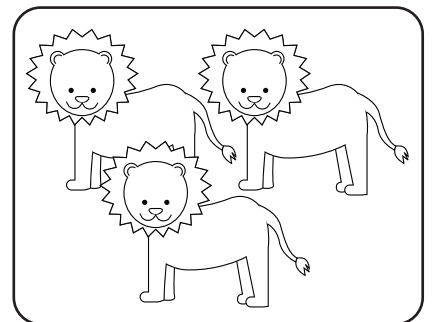
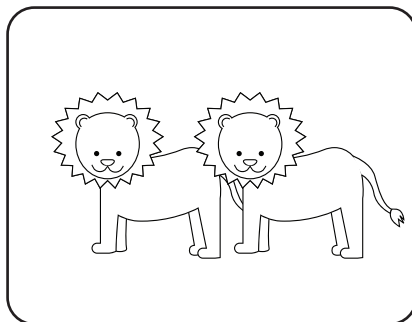
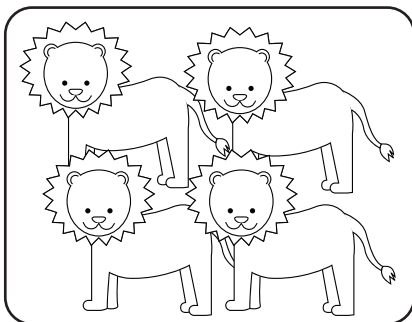

# Number 5

Name \_\_\_\_\_

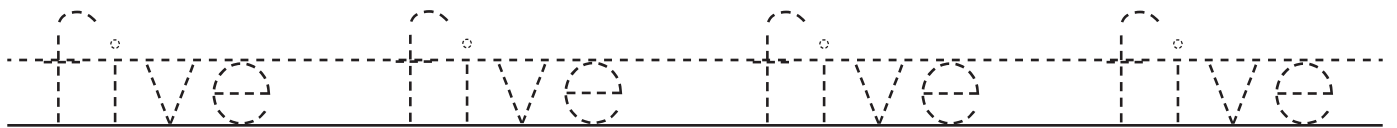
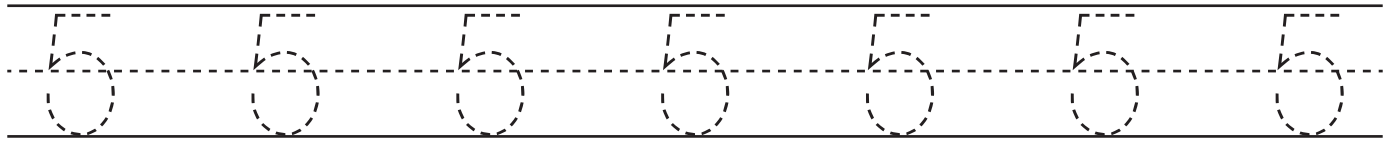
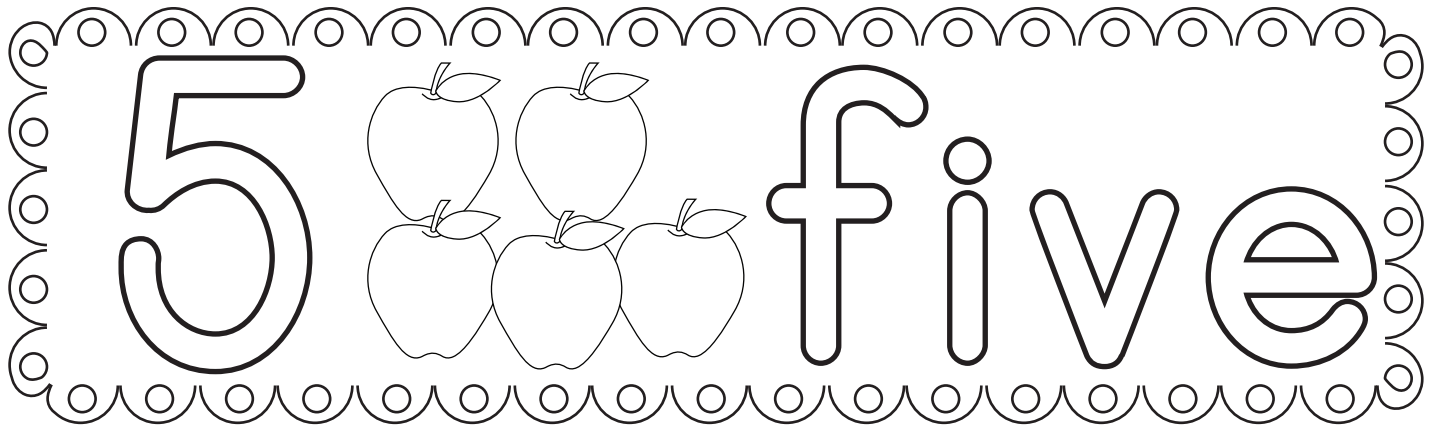

Color 5 stars.

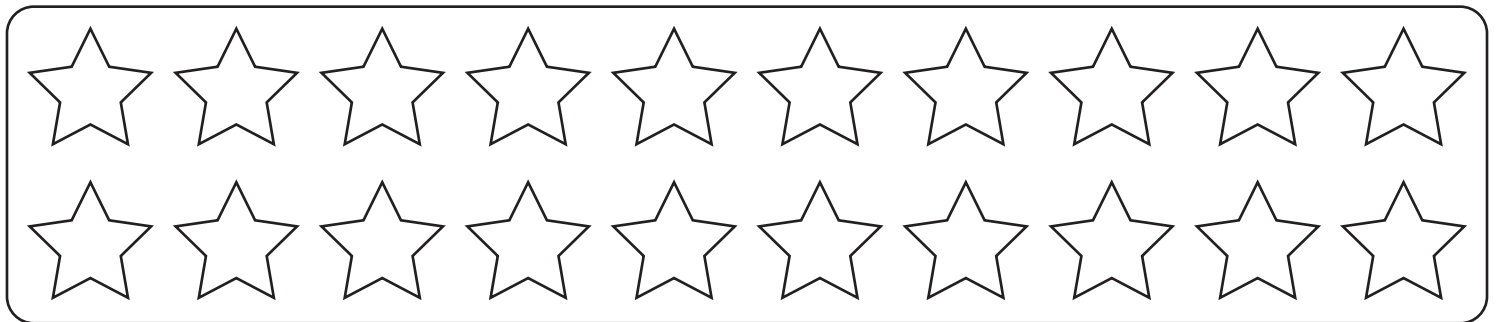

Circle the square with 5 images.

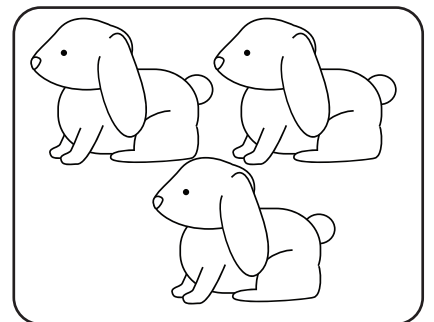
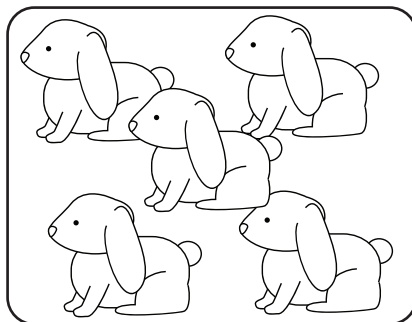
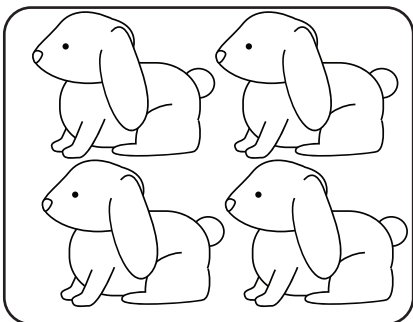

# Number 6

Name \_\_\_\_\_

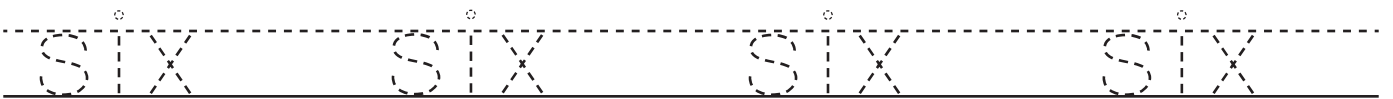
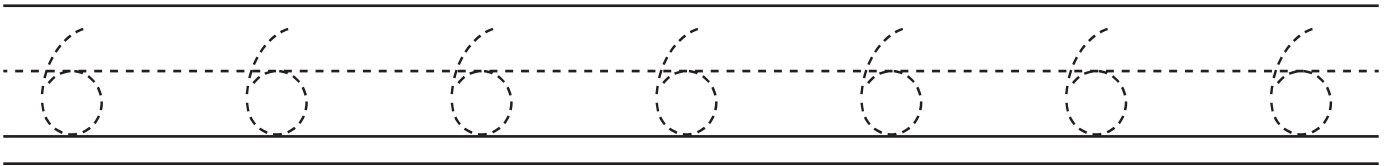

Color 6 stars.

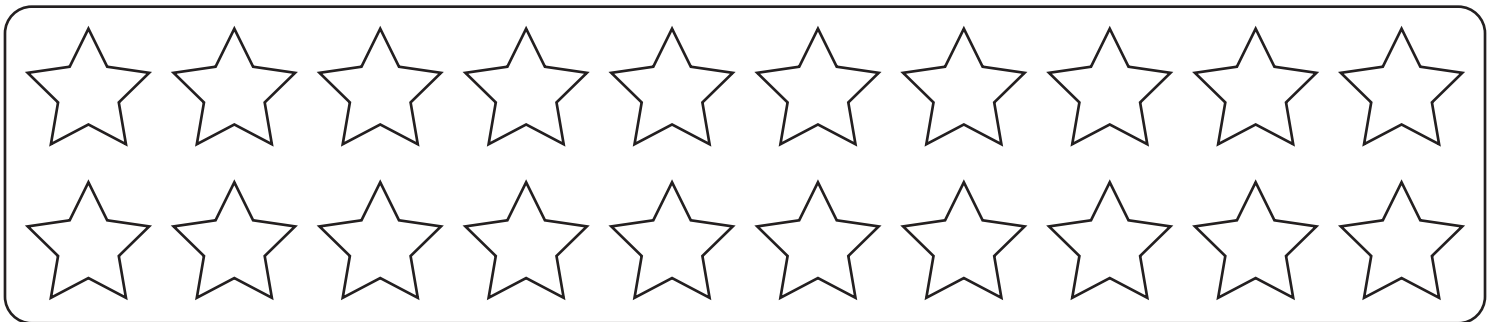

Circle the square with 6 images.

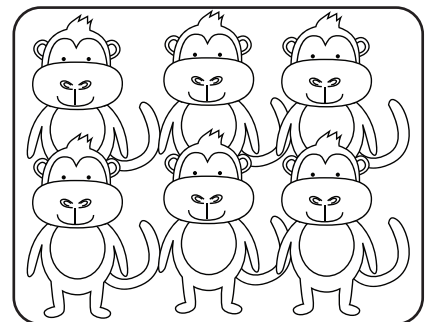
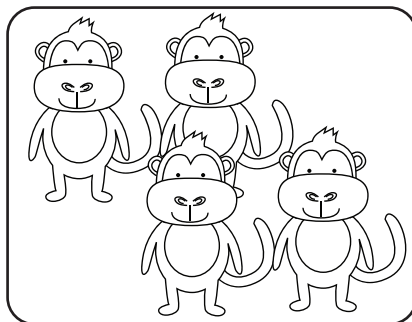
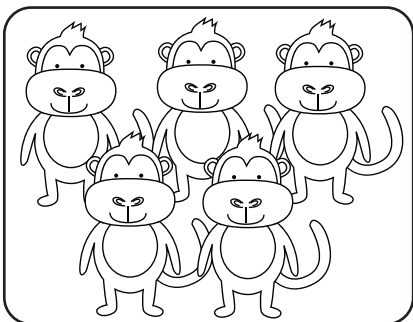

# Number 7

Name \_\_\_\_\_

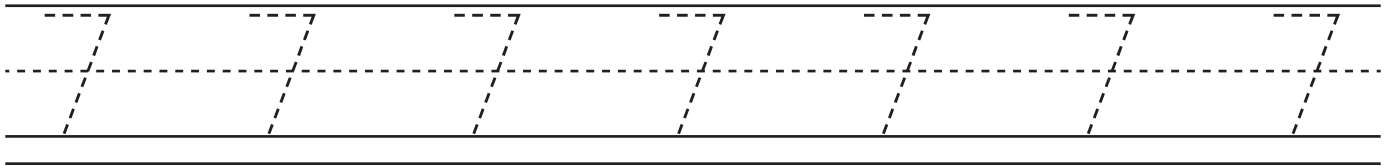

Color 7 stars.

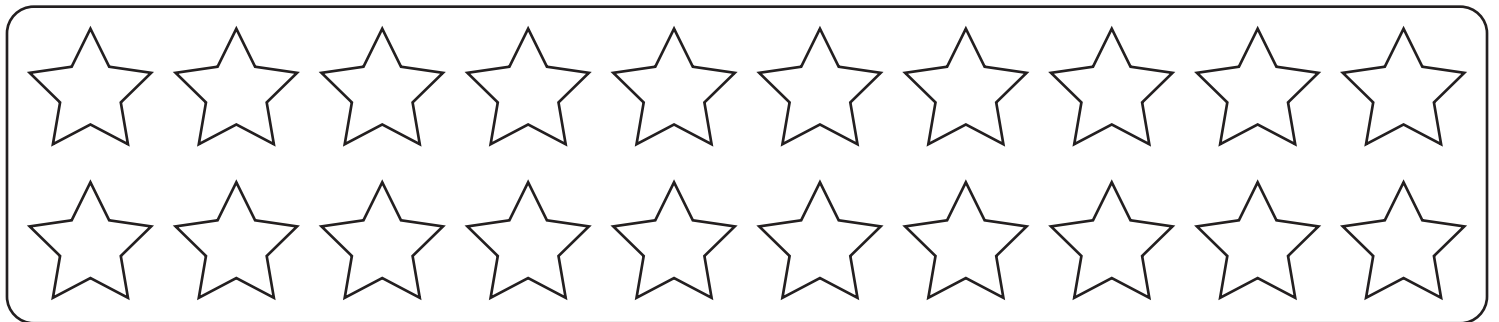

Circle the square with 7 images.

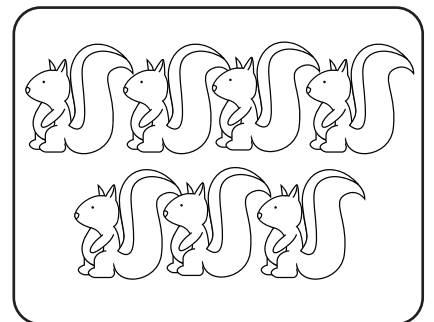
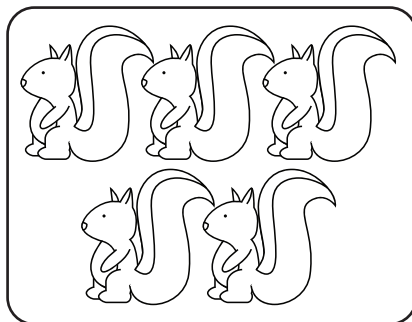
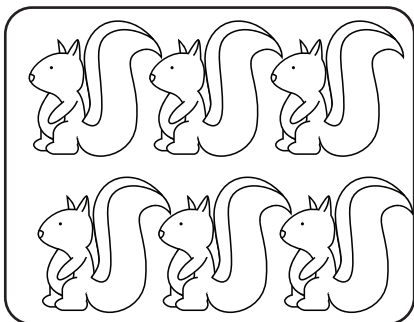

# Number 8

Name \_\_\_\_\_

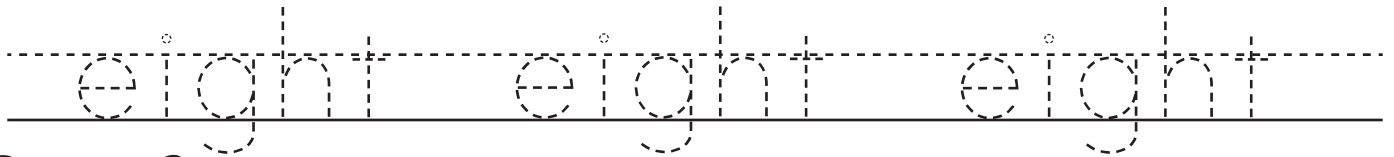
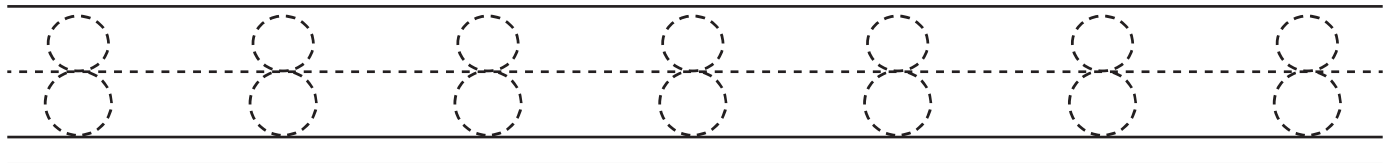
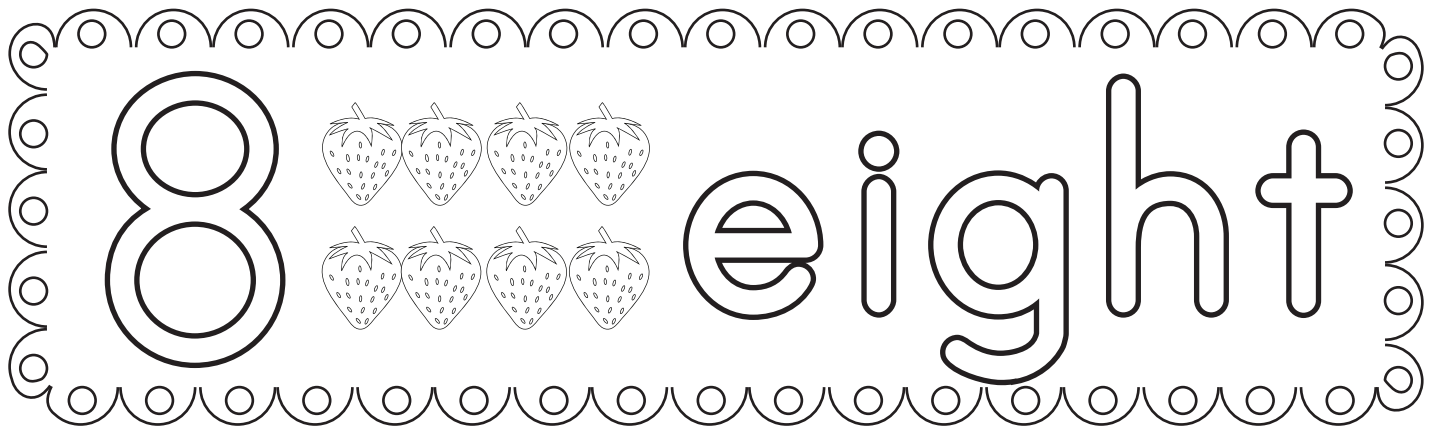

Color 8 stars.

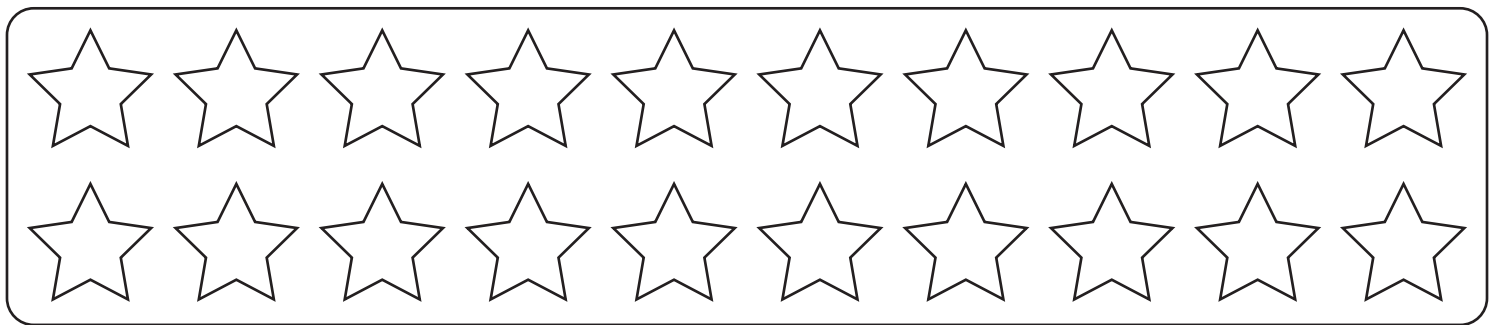

Circle the square with 8 images.

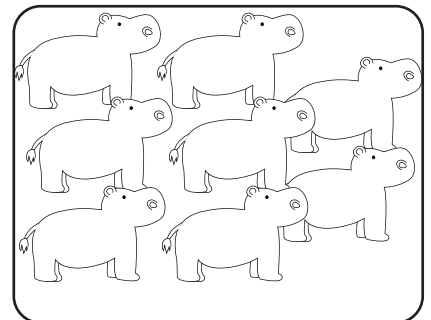
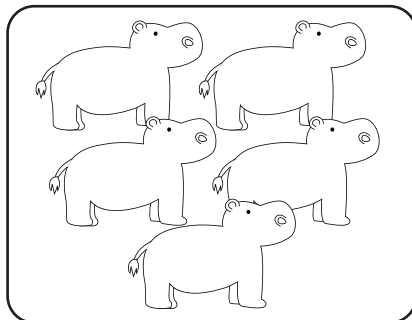
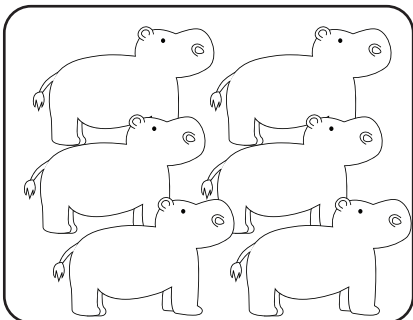

# Number 9

Name \_\_\_\_\_

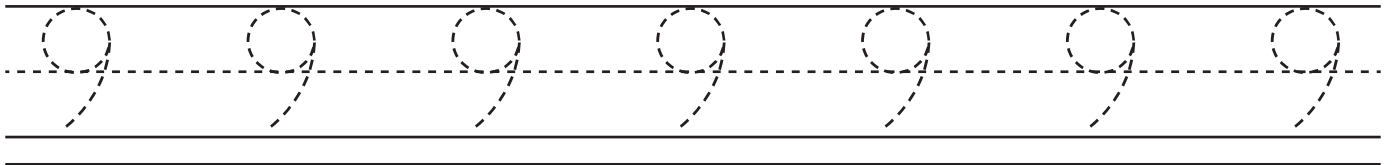
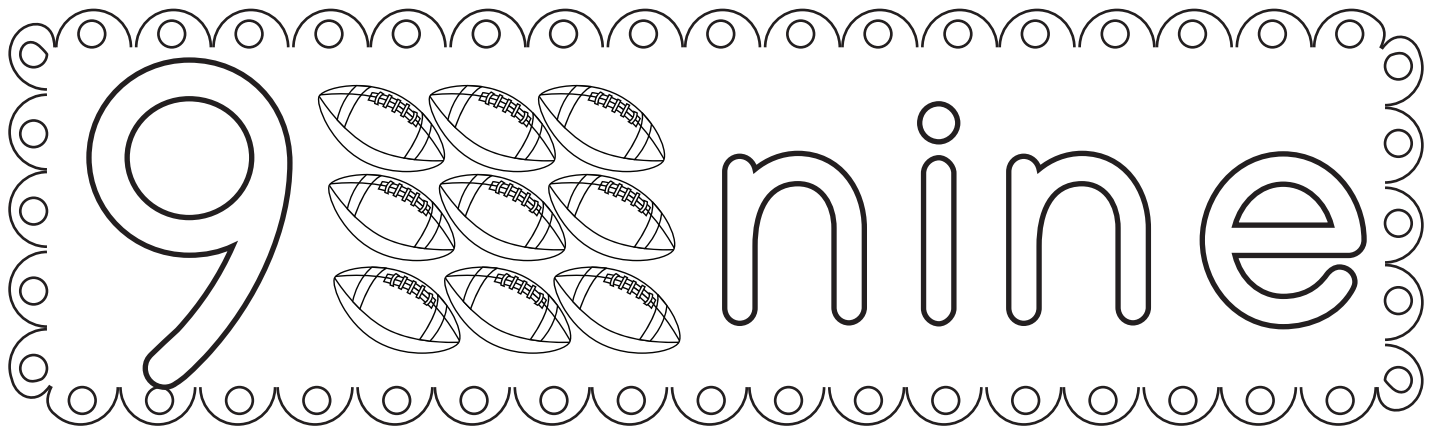

Color 9 stars.

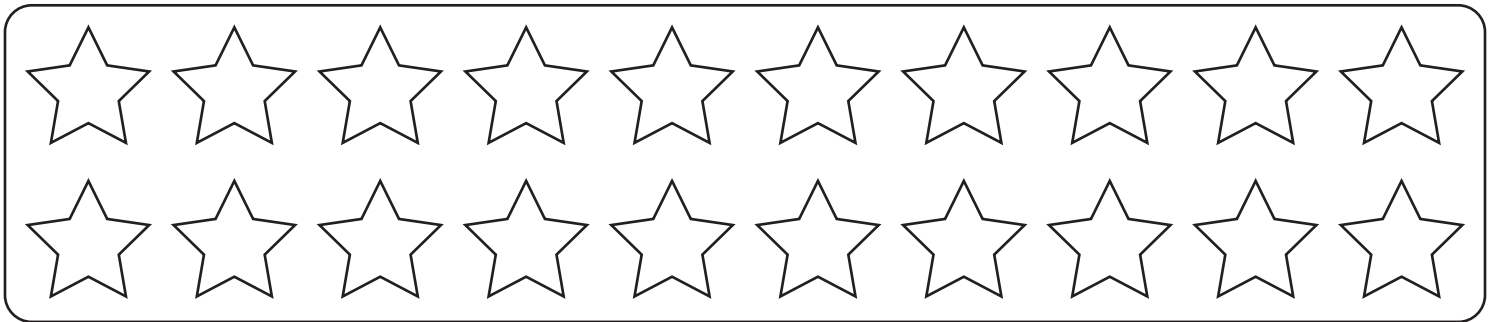

Circle the square with 9 images.

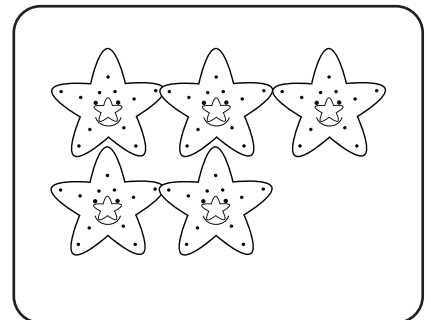
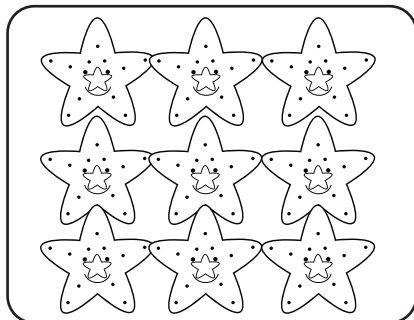
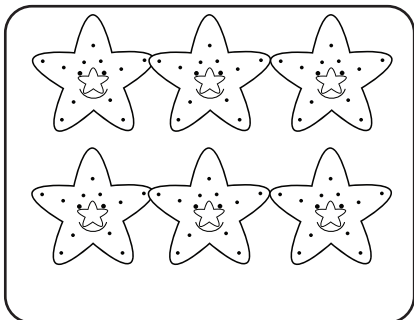

# Number 10

Name \_\_\_\_\_

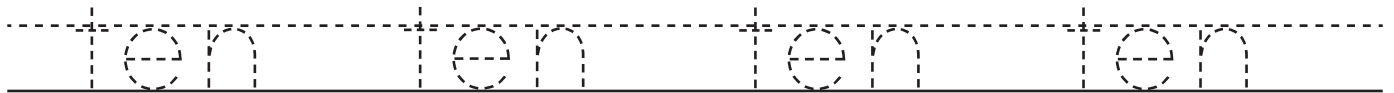
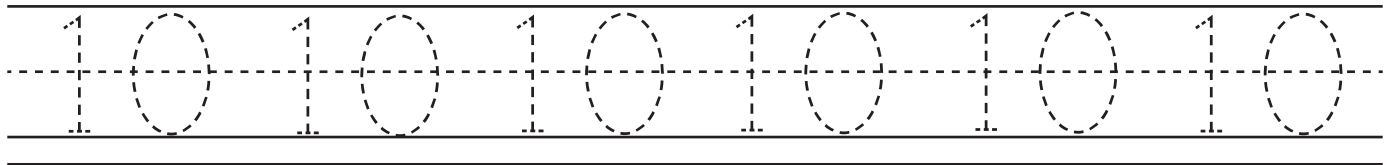
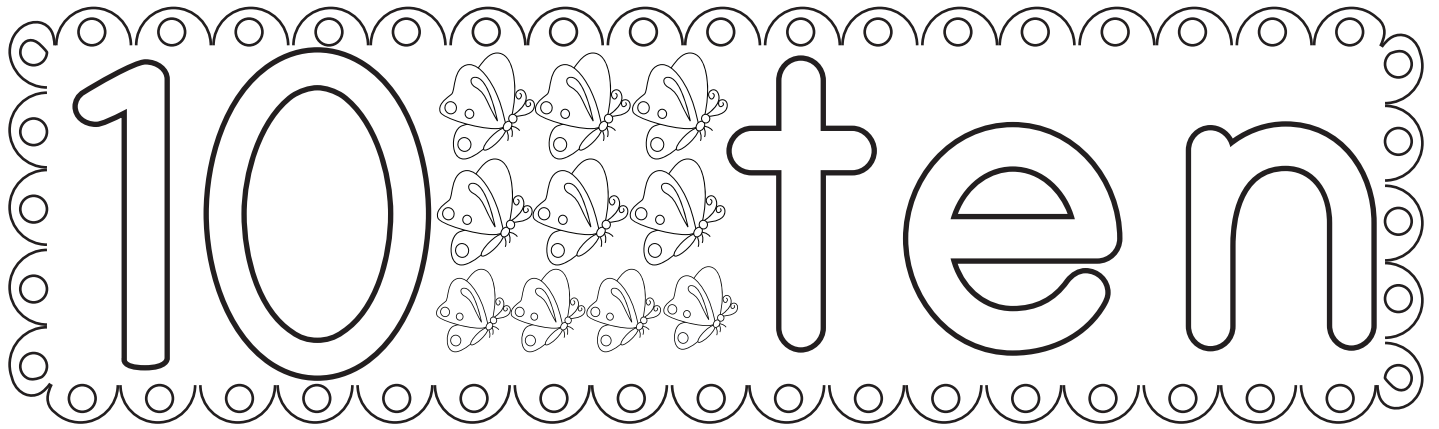

Color 10 stars.

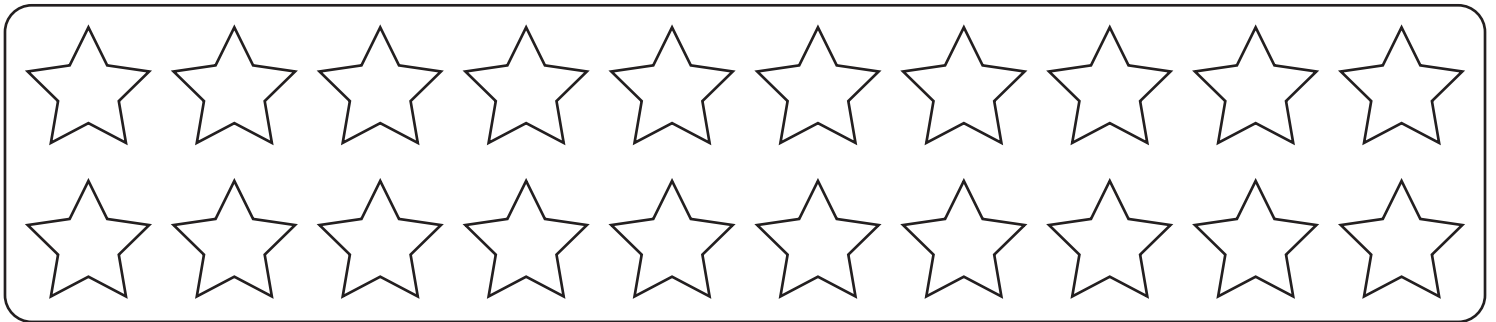

Circle the square with 10 images.

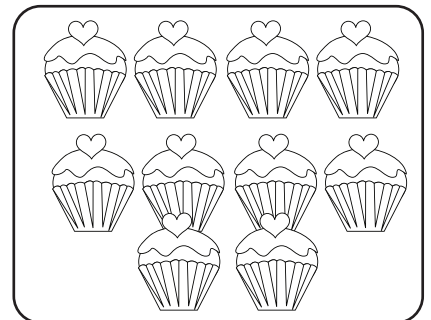
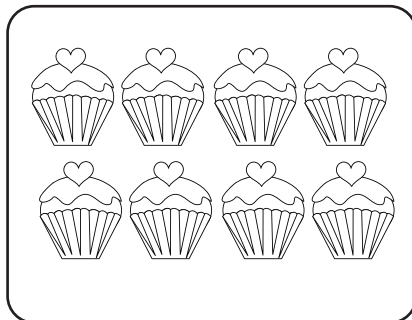
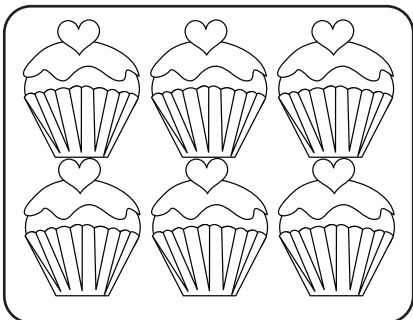

# Number 11

Name \_\_\_\_\_

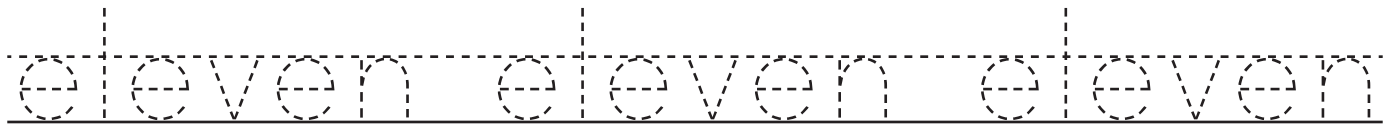
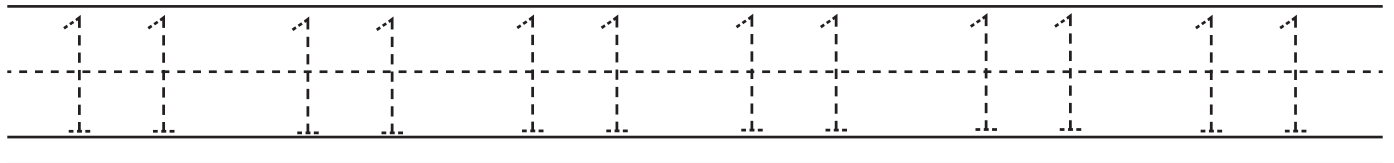

Color 11 stars.

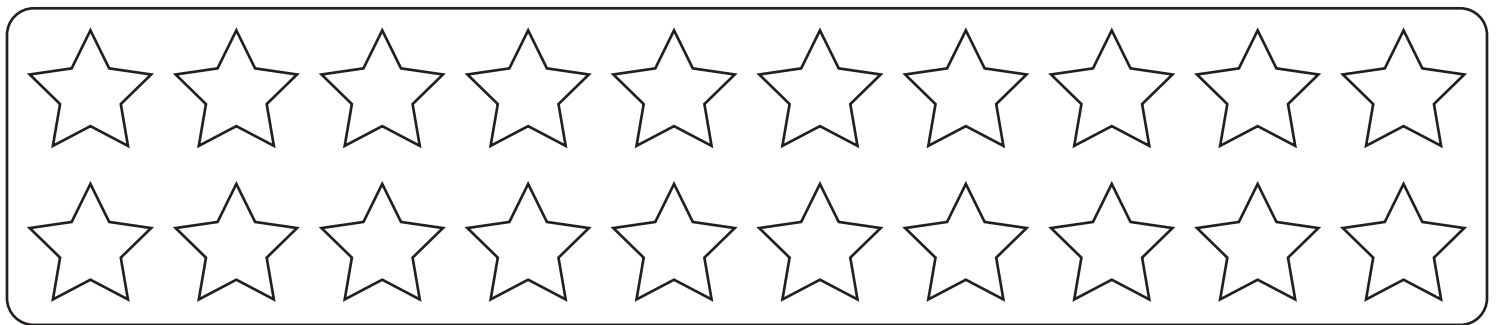

Circle the square with 11 images.

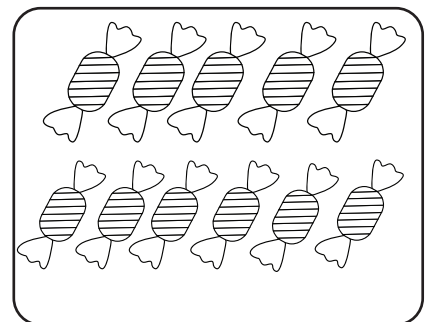
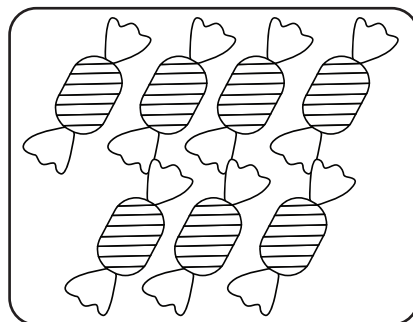
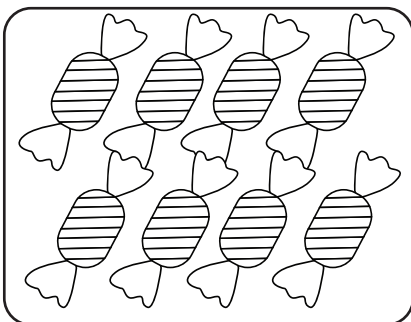

# Number 12

Name \_\_\_\_\_

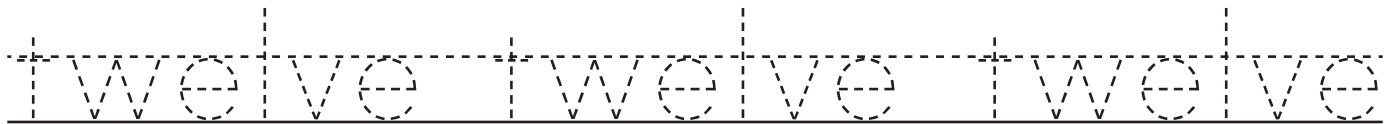
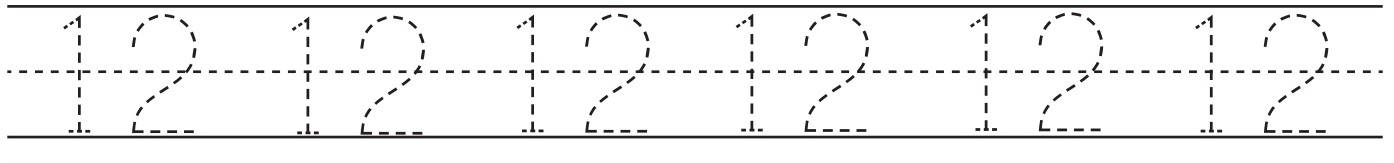

Color 12 stars.

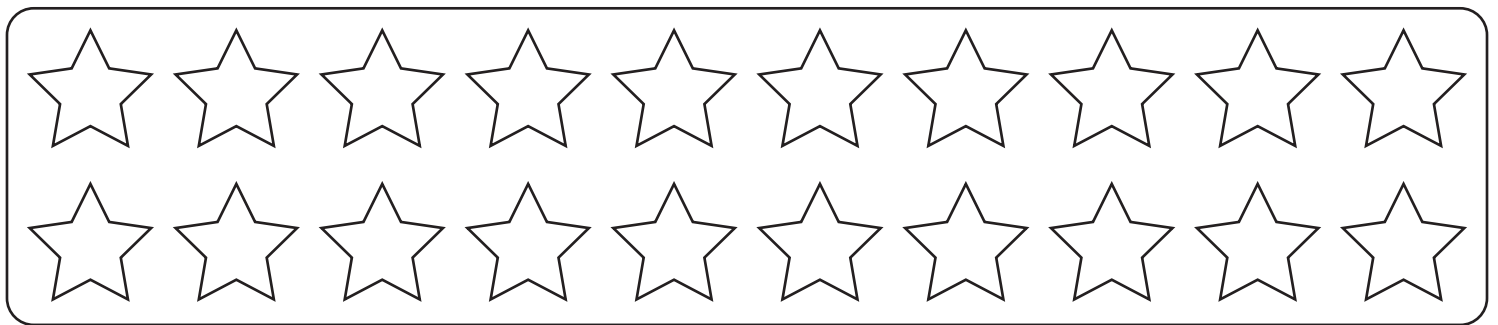

Circle the square with 12 images.

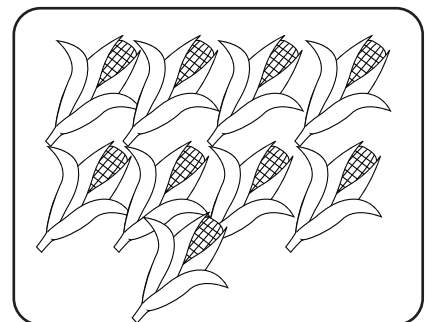
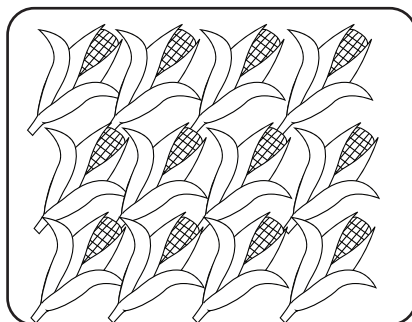
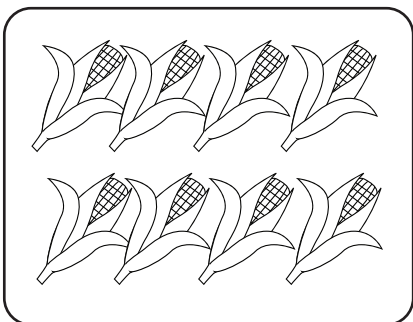

# Number 13

Name \_\_\_\_\_

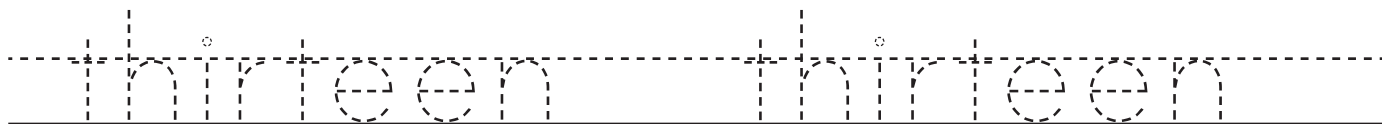
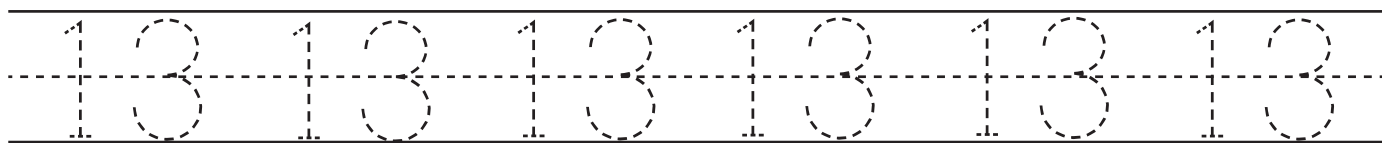

Color 13 stars.

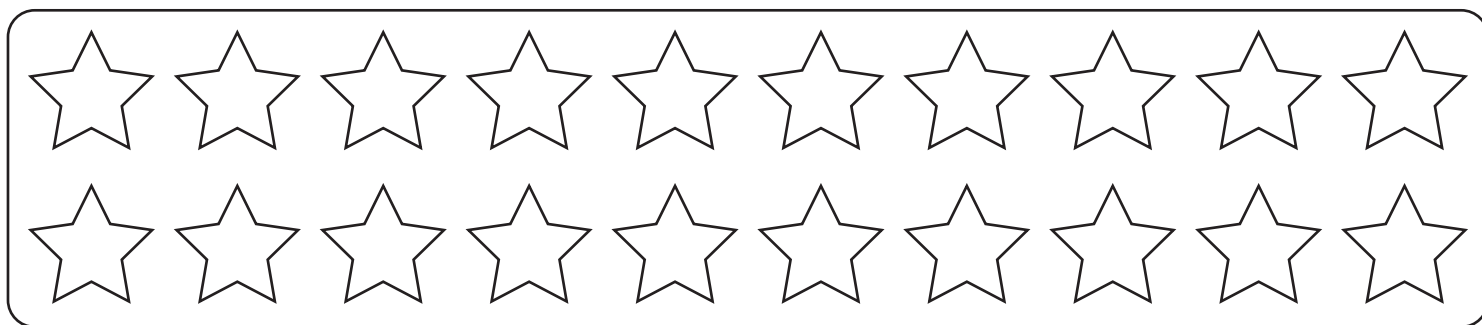

Circle the square with 13 images.

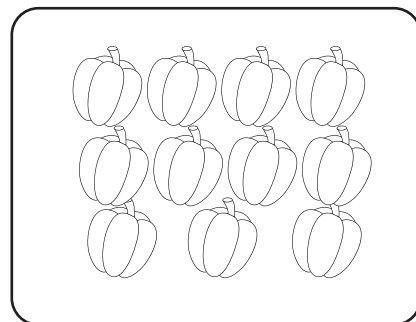
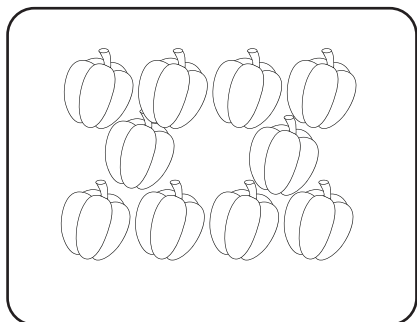
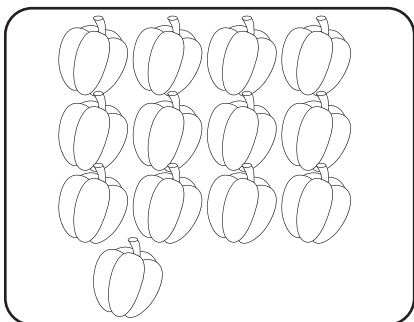

# Number 14

Name \_\_\_\_\_

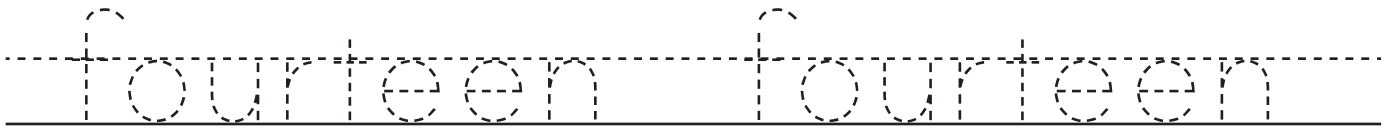
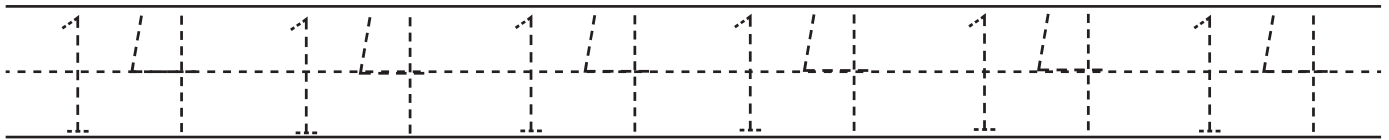

Color 14 stars.

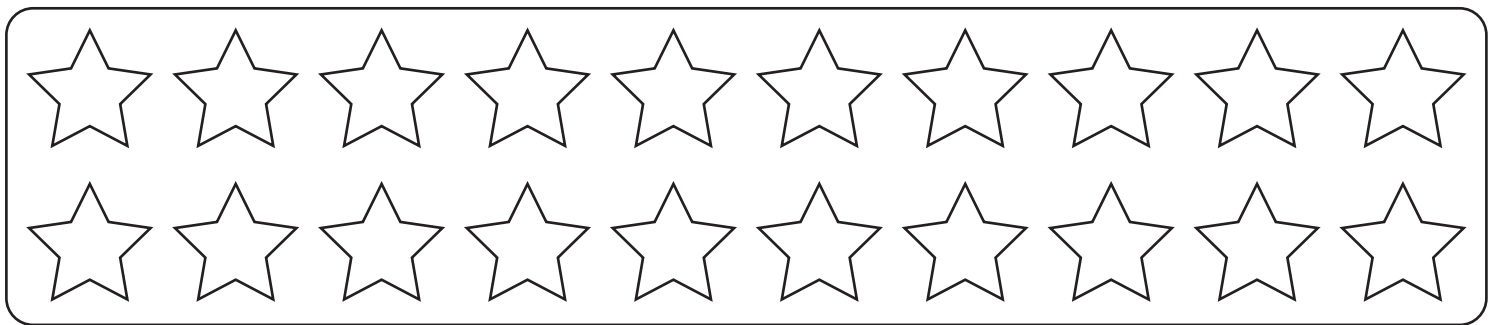

Circle the square with 14 images.

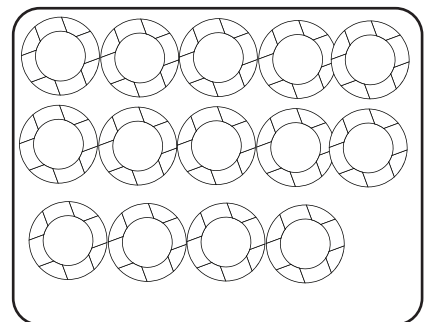
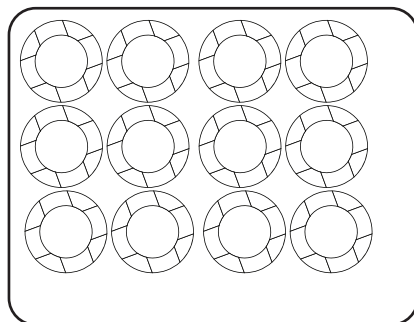
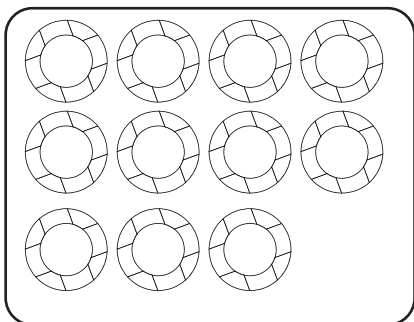

# Number 15

Name \_\_\_\_\_

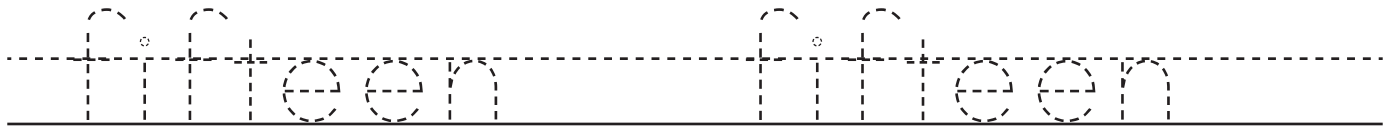
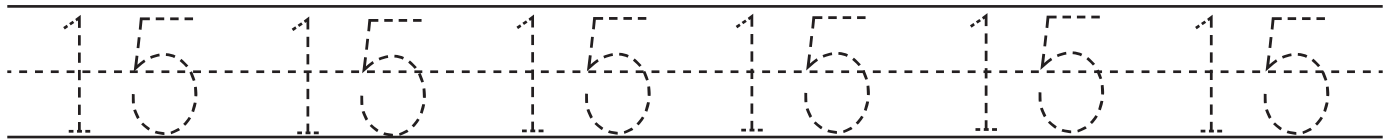
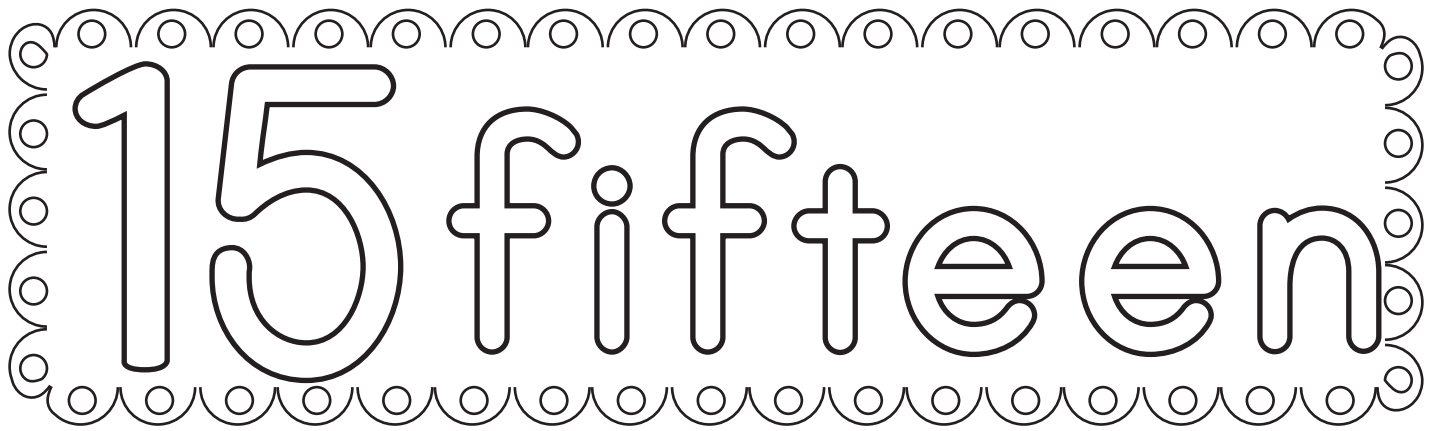

Color 15 stars.

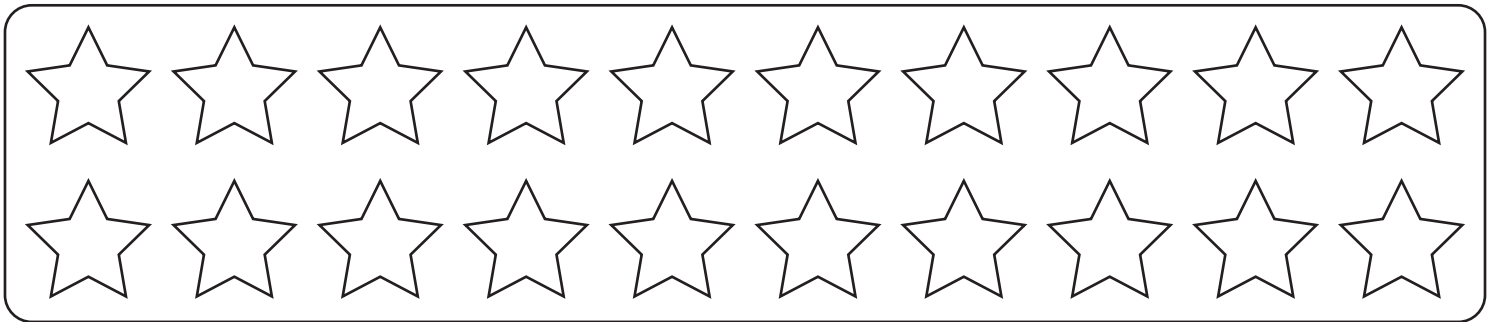

Circle the square with 15 images.

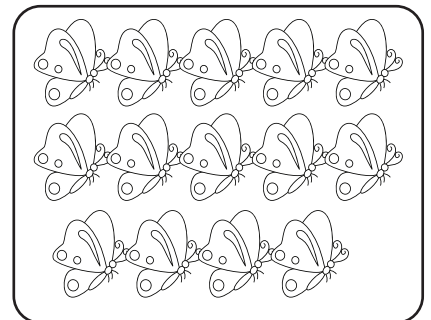
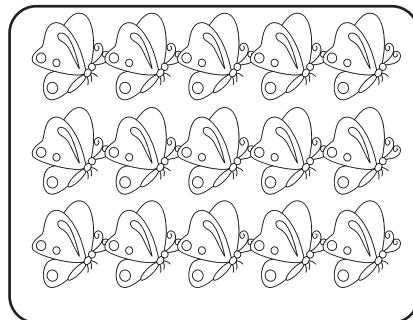
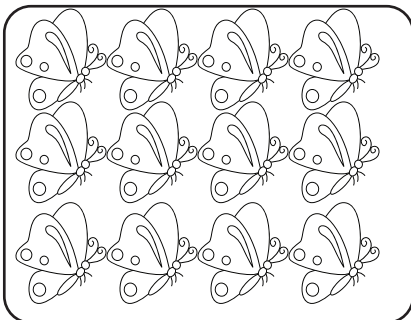

# Number 16

Name \_\_\_\_\_

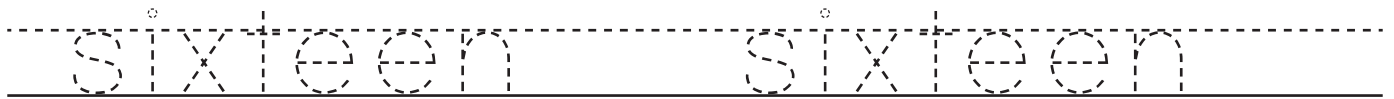
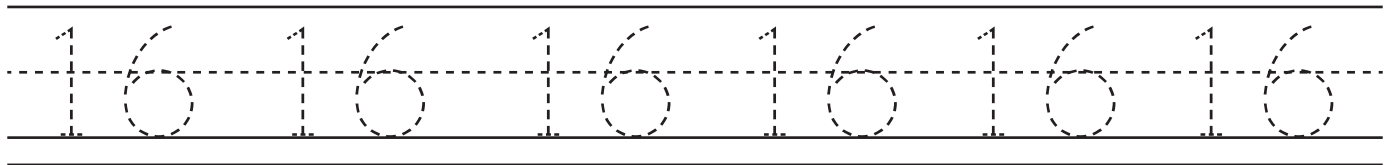

Color 16 stars.

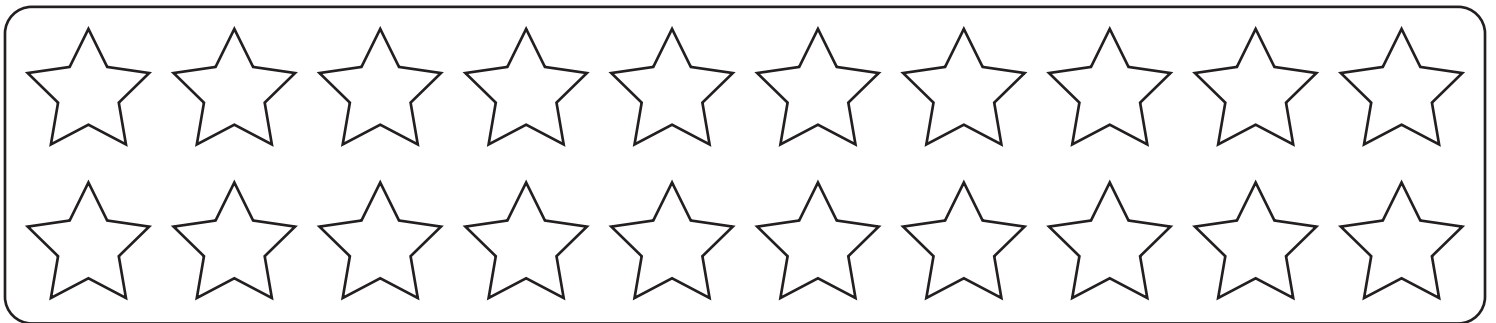

Circle the square with 16 images.

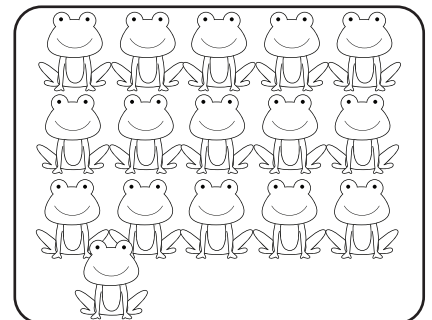
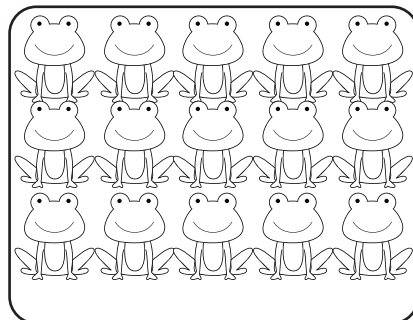
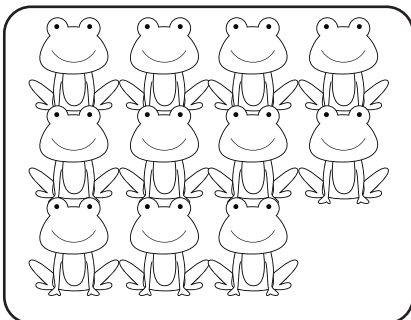

# Number 17

Name \_\_\_\_\_

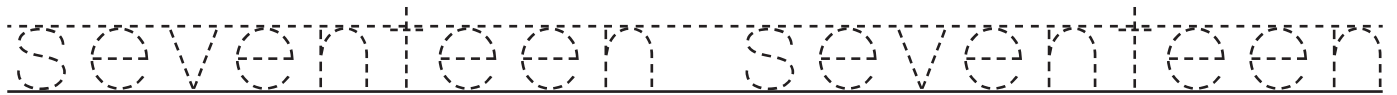
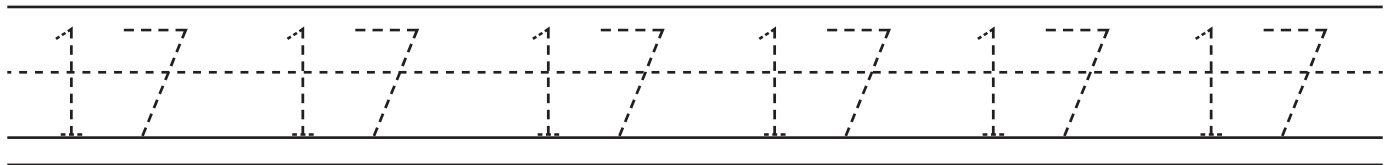

Color 17 stars.

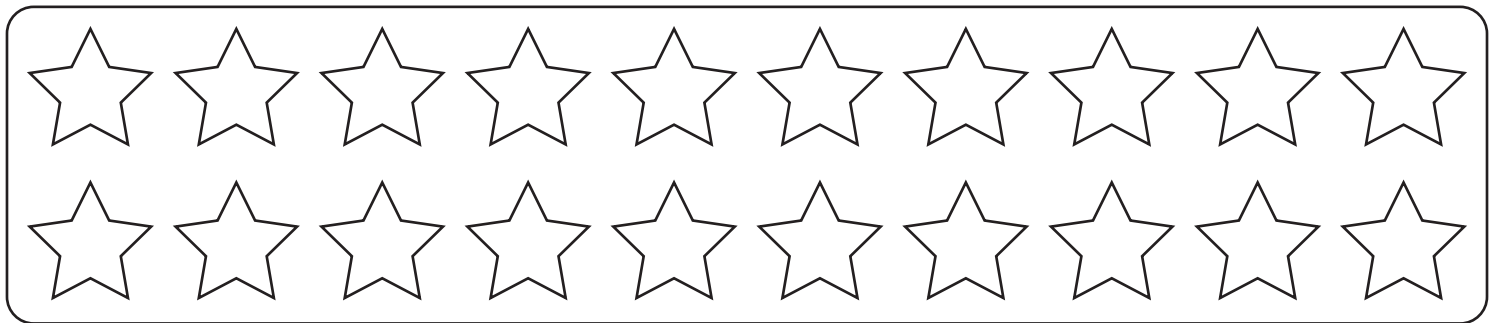

Circle the square with 17 images.

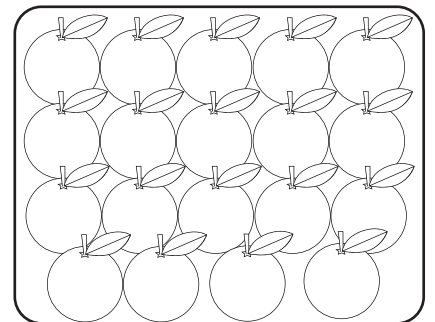
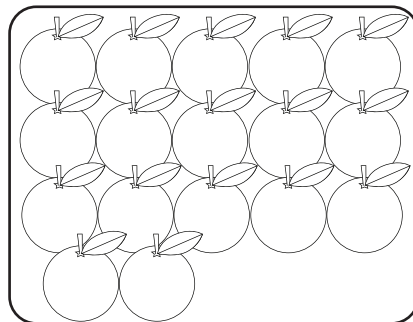
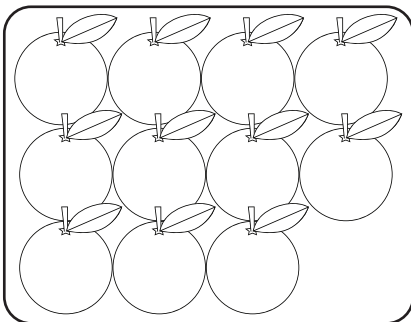

# Number 18

Name \_\_\_\_\_

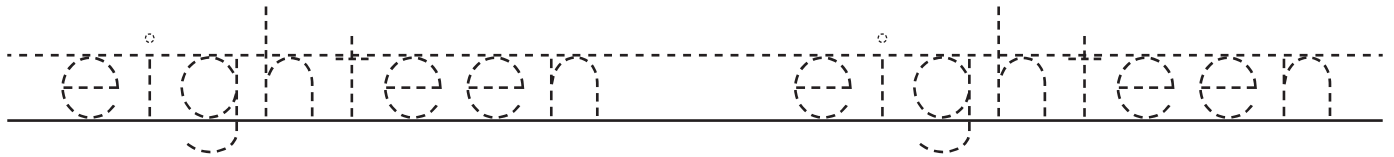
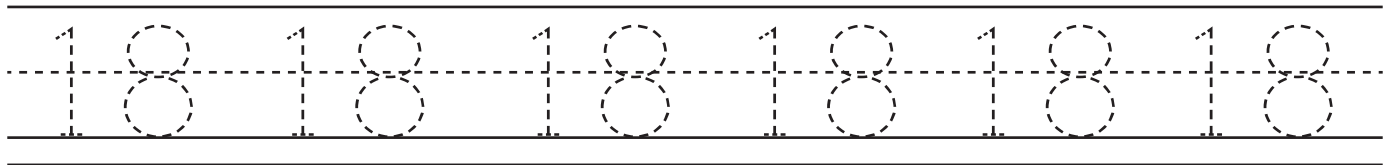

Color 18 stars.

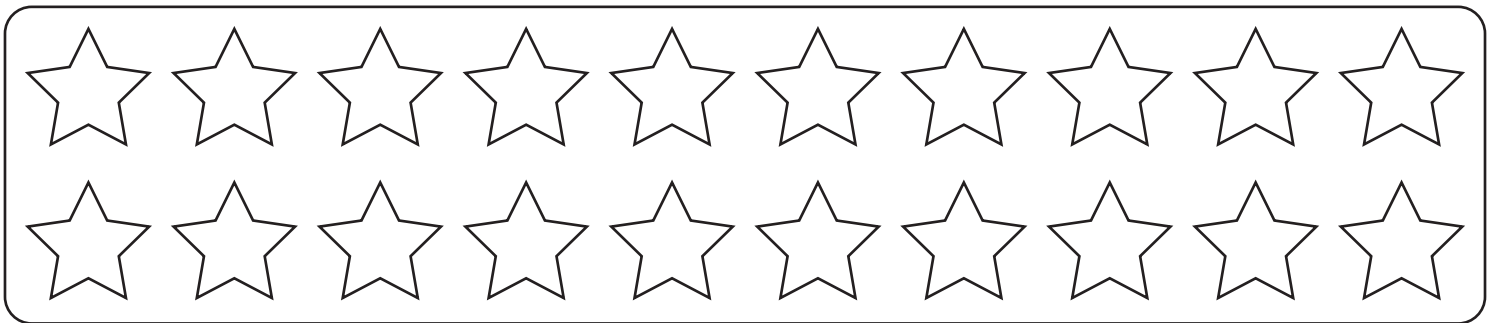

Circle the square with 18 images.

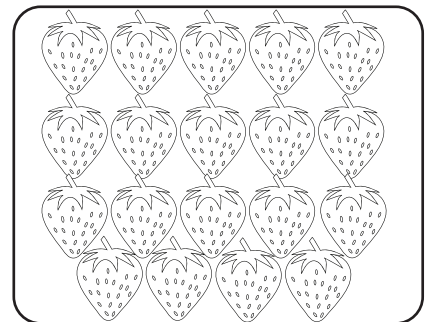
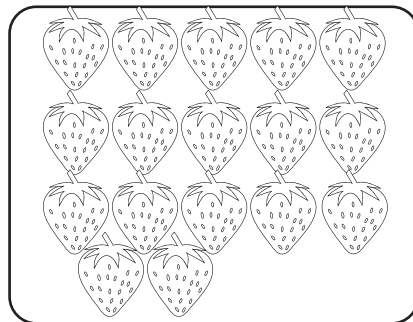
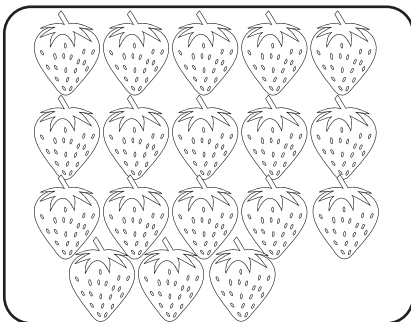

# Number 19

Name \_\_\_\_\_

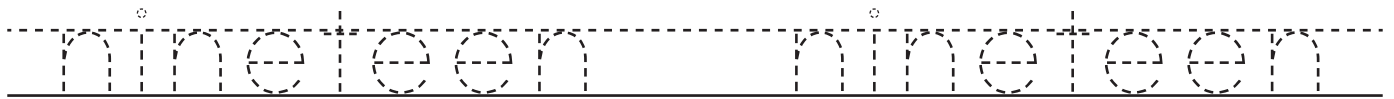
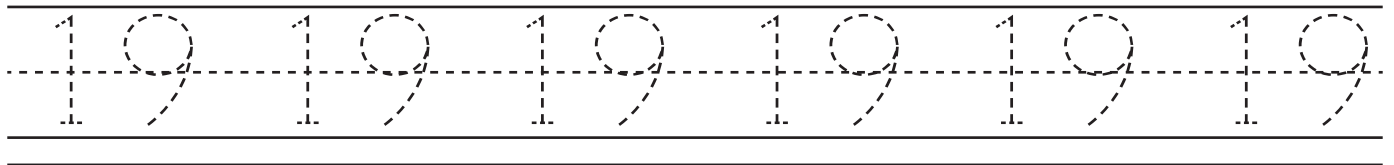

Color 19 stars.

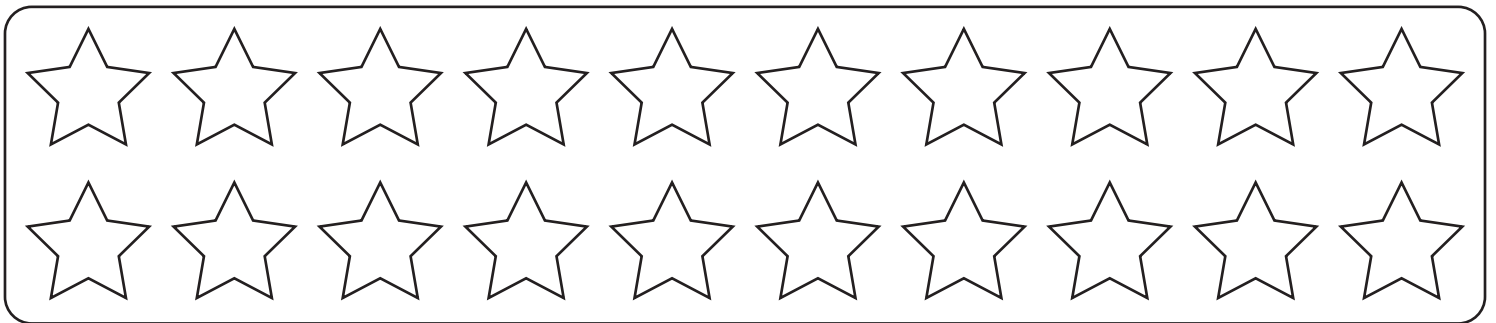

Circle the square with 19 images.

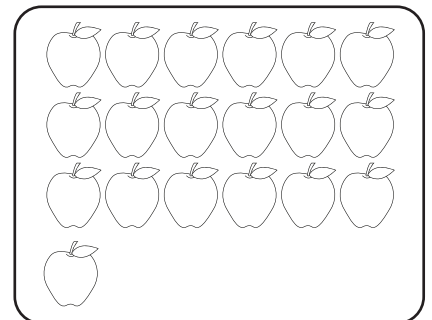
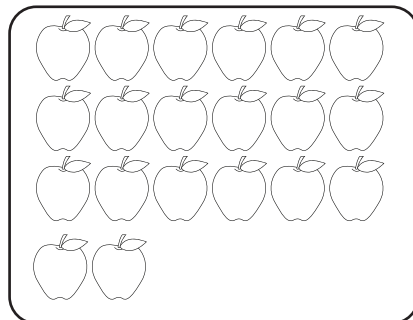
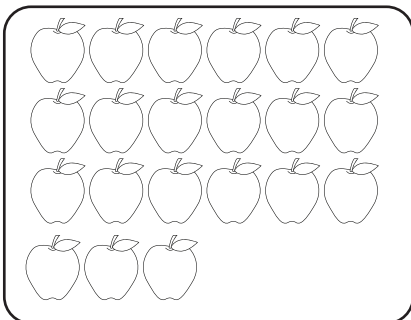

# Number 20

Name \_\_\_\_\_

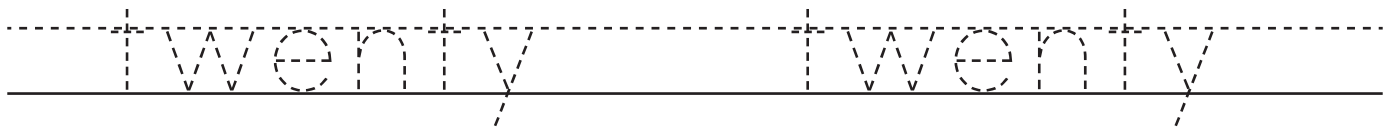
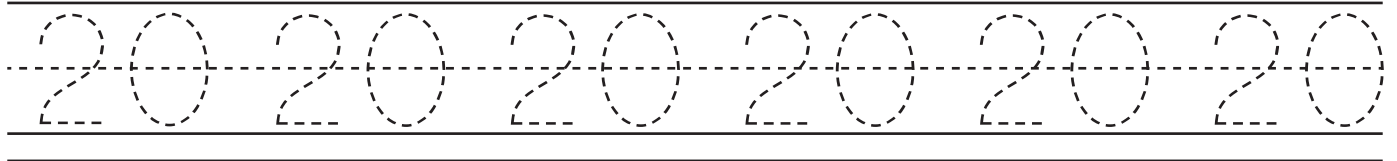

Color 20 stars.

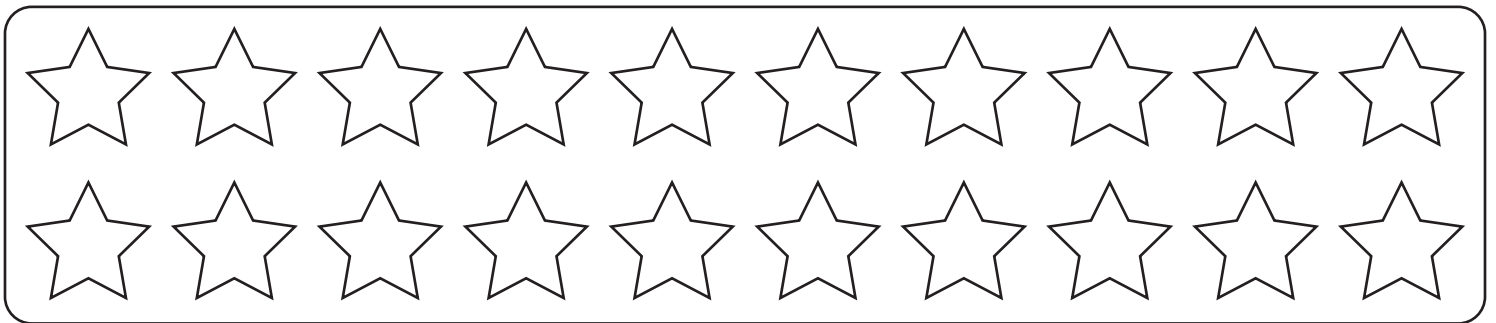

Circle the square with 20 images.

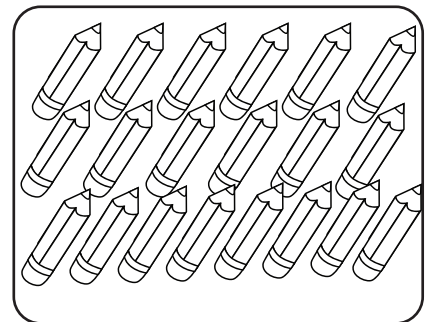
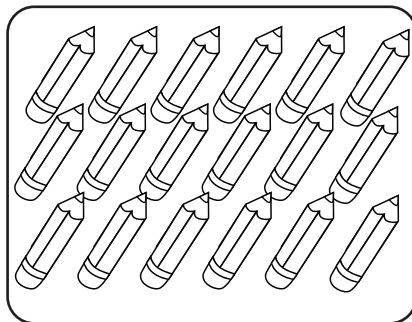
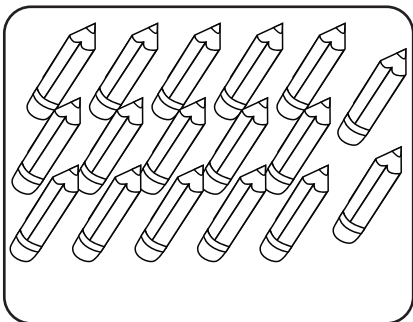

# Missing Numbers 1 to 10

Name \_\_\_\_\_

Trace the numbers and write each missing number.

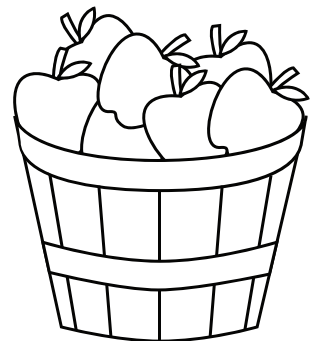
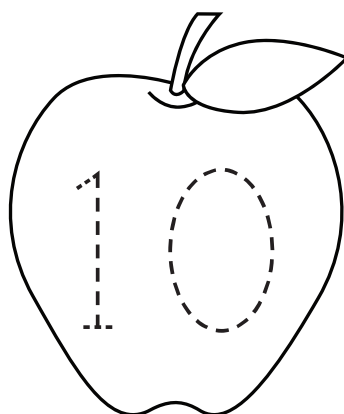
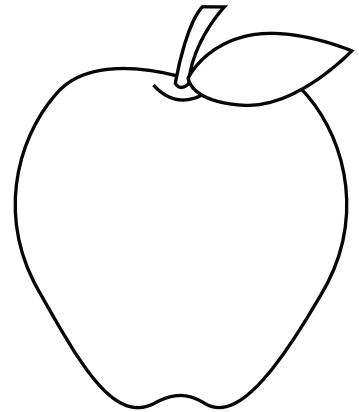
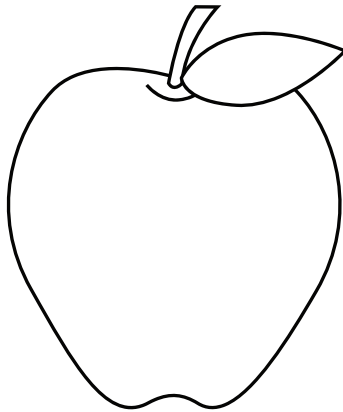
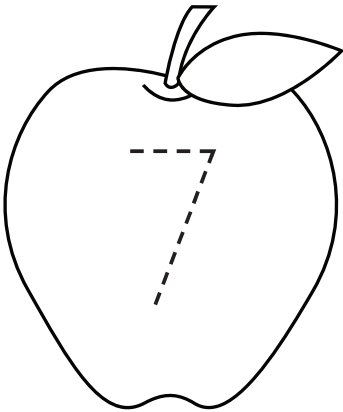
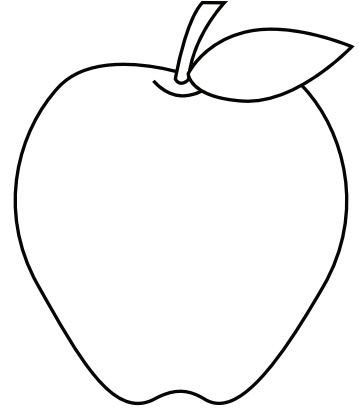
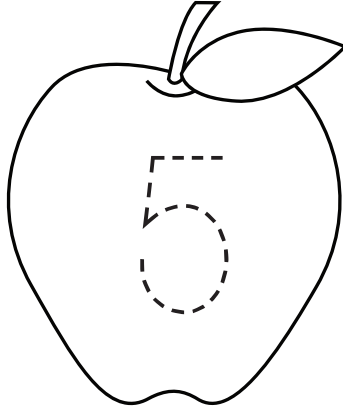
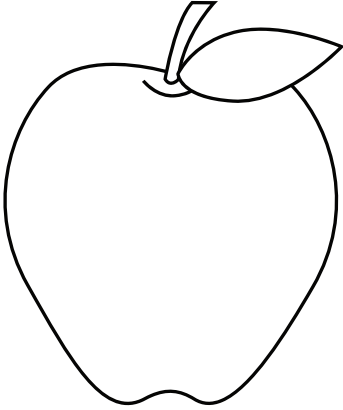
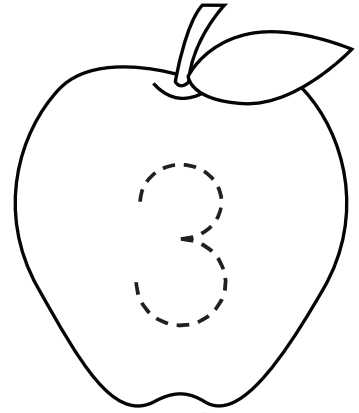
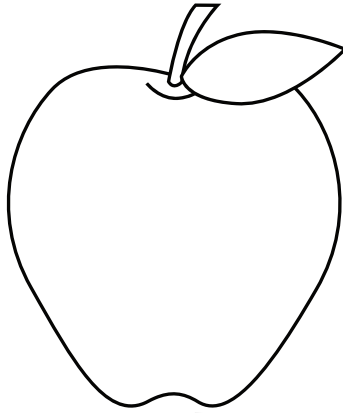
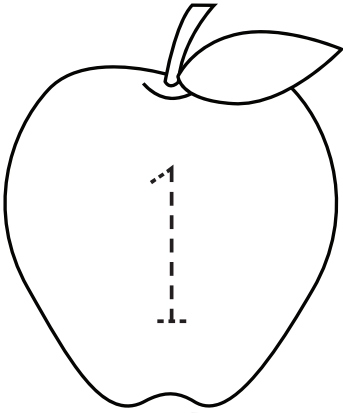

# Missing Numbers 1 to 10

Name \_\_\_\_\_

Trace the numbers and write each missing number.

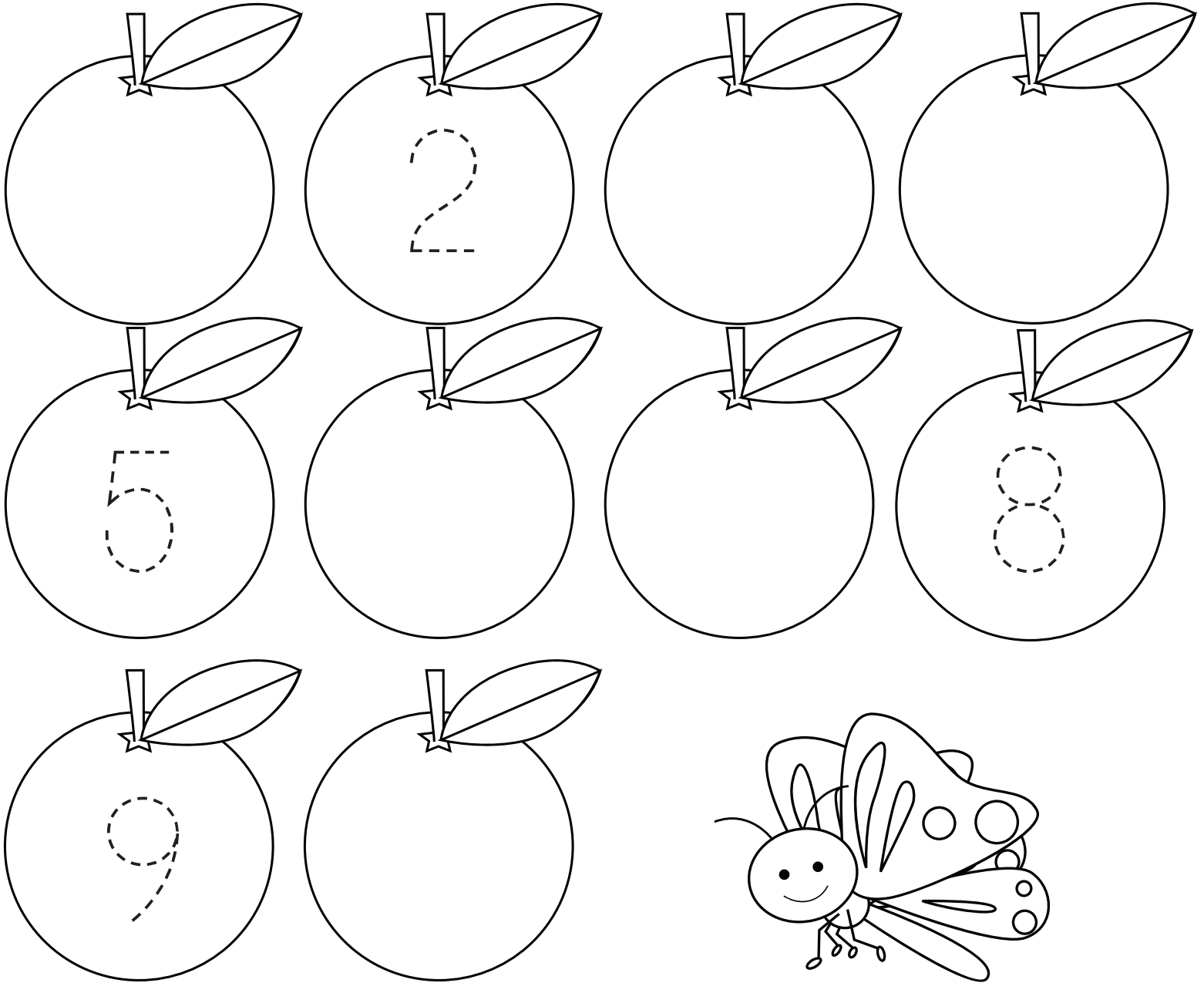

# Missing Numbers 1 to 10

Name \_\_\_\_\_

Trace the numbers and write each missing number.

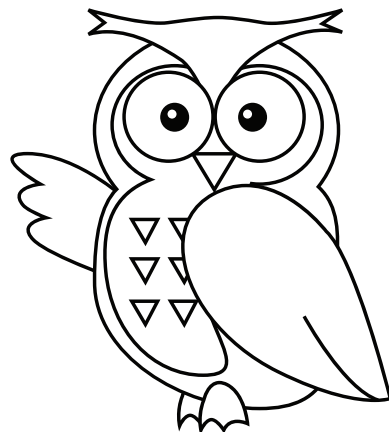
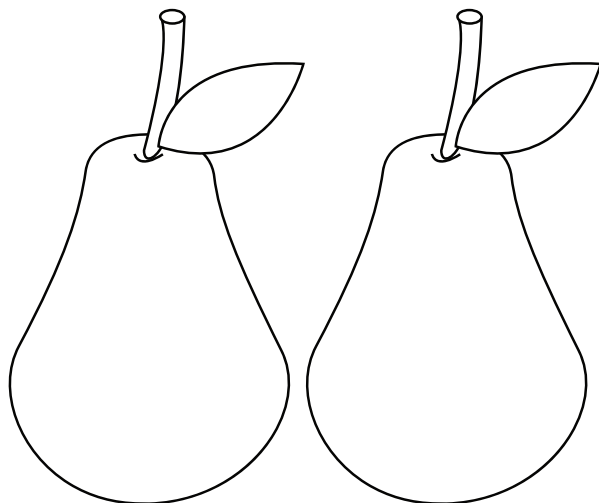
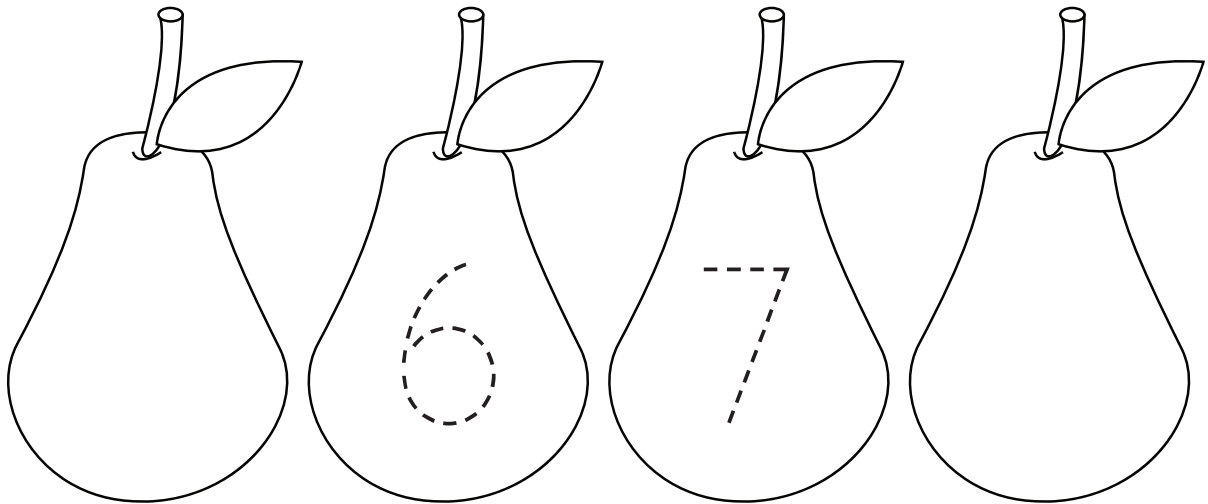
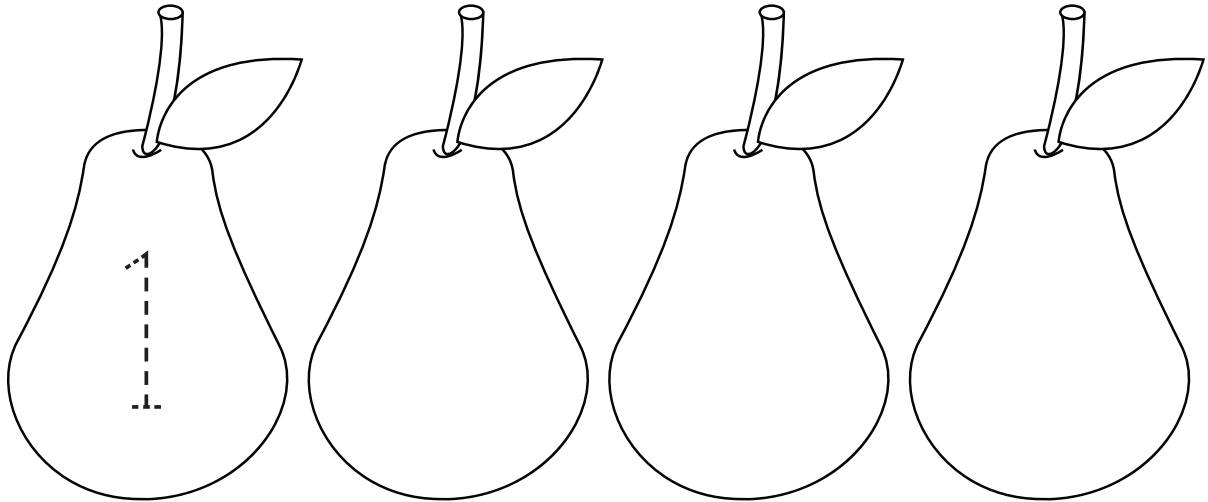

# Missing Numbers 1 to 20

Name \_\_\_\_\_

Trace the numbers and write each missing number:

1

\_\_\_\_\_

3

\_\_\_\_\_

5

7

\_\_\_\_\_

\_\_\_\_\_

\_\_\_\_\_

10

11

\_\_\_\_\_

13

\_\_\_\_\_

15

17

\_\_\_\_\_

\_\_\_\_\_

\_\_\_\_\_

20

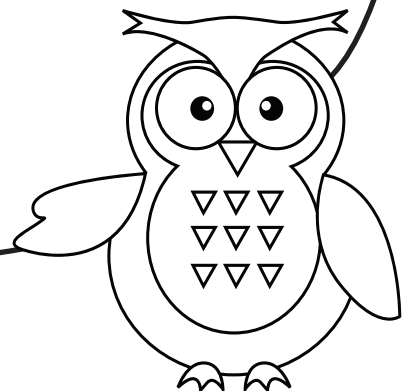

# Missing Numbers 1 to 20

Name \_\_\_\_\_

Trace the numbers and write each missing number.

2

5

6

9

13

15

18

\_\_\_\_\_

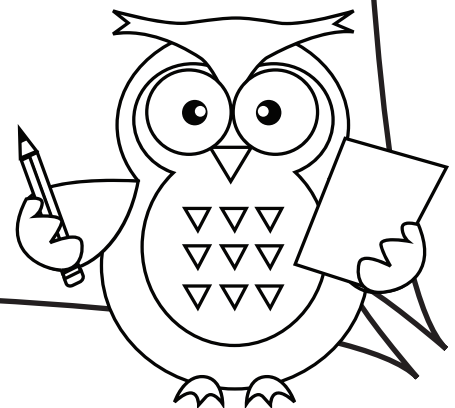

# Missing Numbers 1 to 20

Name \_\_\_\_\_

Trace the numbers and write each missing number.

3

7

9

10

12

14

16

18

20

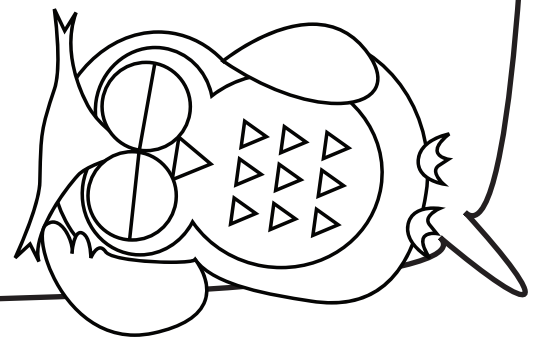

# Before and After

Name \_\_\_\_\_

Write the number that comes before and after each number in the middle.

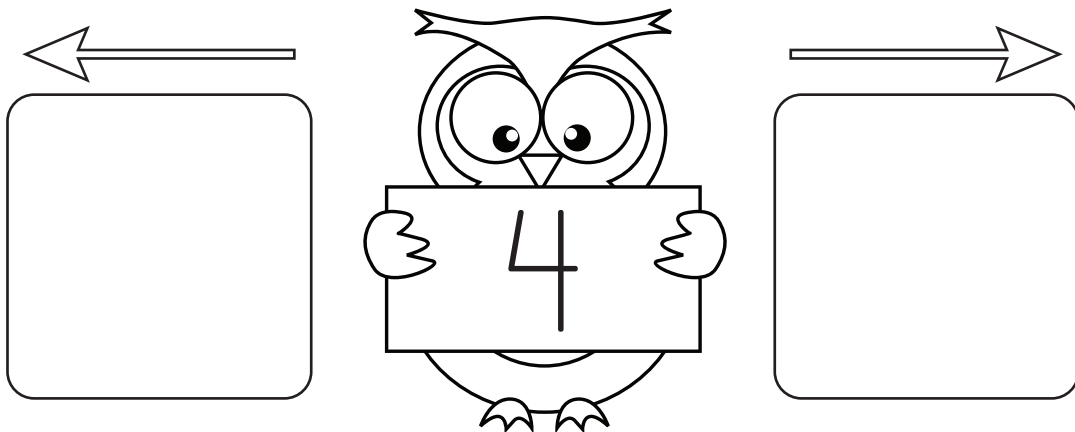

# Before and After

Name \_\_\_\_\_

Write the number that comes before and after each number in the middle.

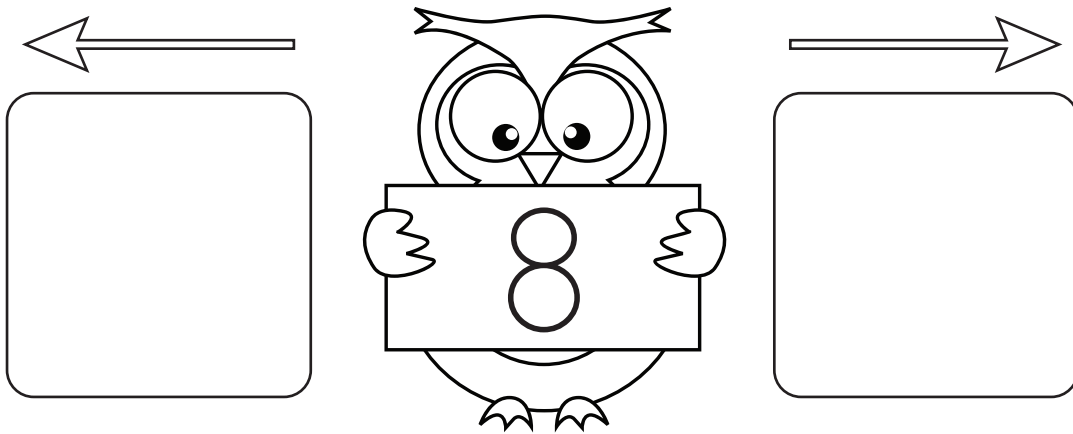

# Before and After

Name \_\_\_\_\_

Write the number that comes before and after each number in the middle.

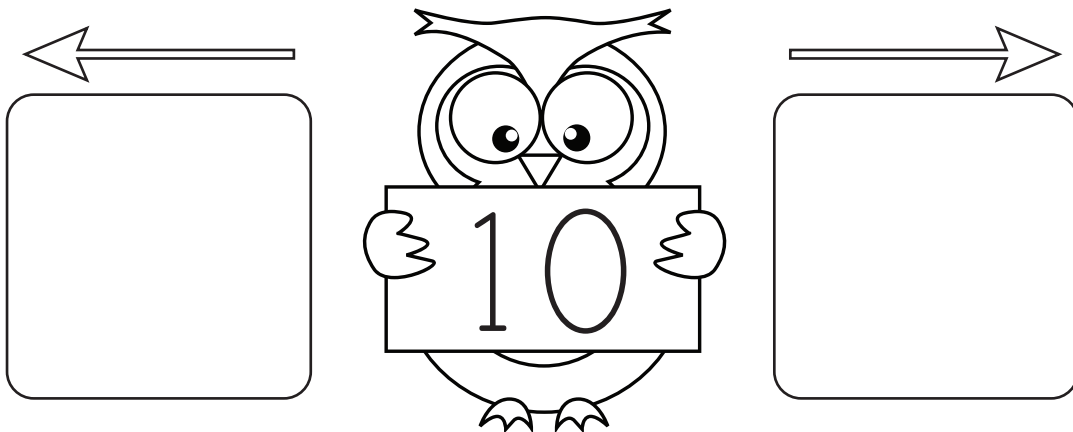
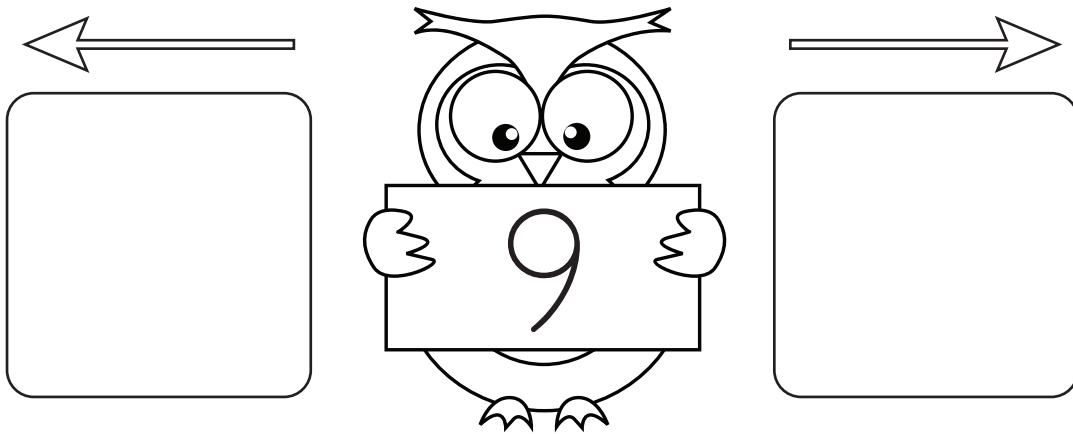

# Before and After

Name \_\_\_\_\_

Write the number that comes before and after each number in the middle.

←		→
□		□

←		→
□		□

←		→
□		□

# Before and After

Name \_\_\_\_\_

Write the number that comes before and after each number in the middle.

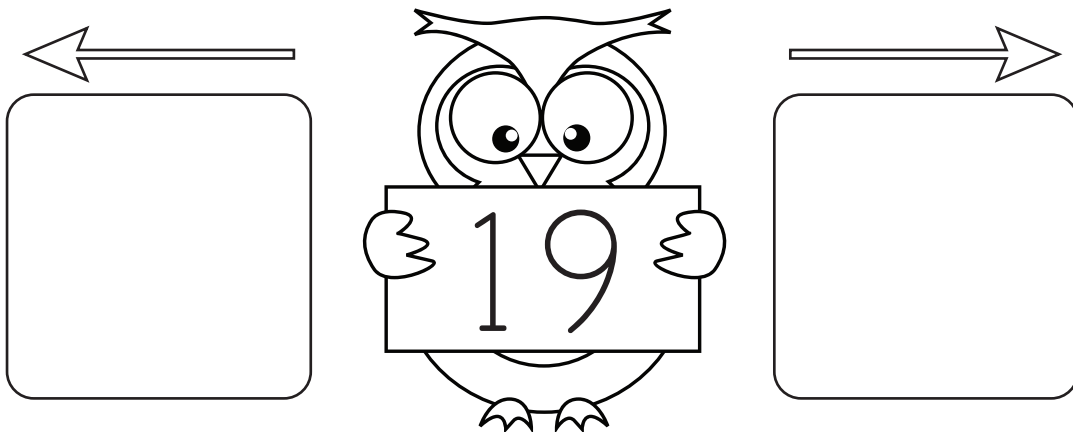

# More or Less

Name \_\_\_\_\_

Count the number of images and write the total number in each box.  
Circle the box with more images in each row.

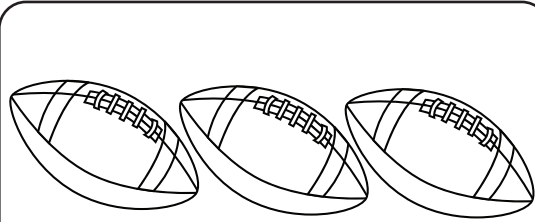

Total Number: \_\_\_\_\_

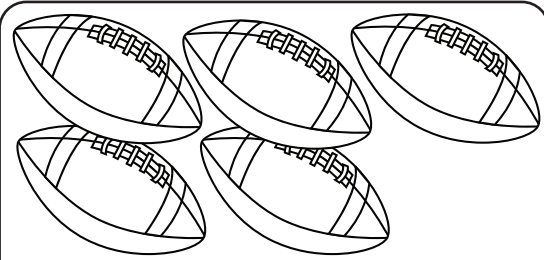

Total Number: \_\_\_\_\_

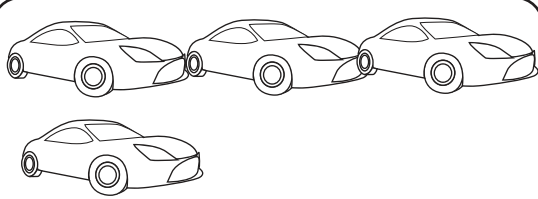

Total Number: \_\_\_\_\_

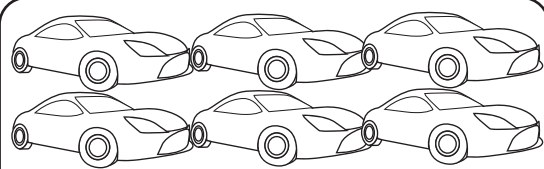

Total Number: \_\_\_\_\_

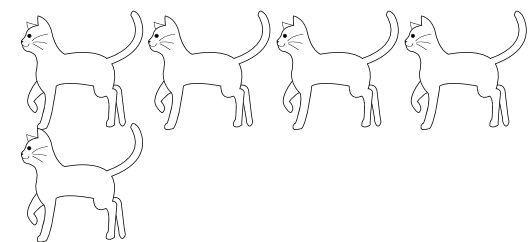

Total Number: \_\_\_\_\_

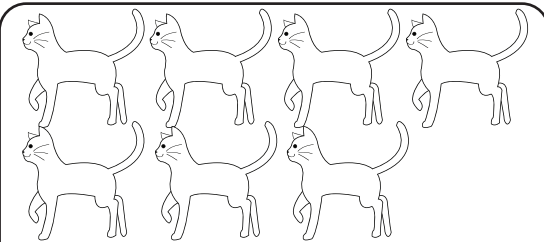

Total Number: \_\_\_\_\_

# More or Less

Name \_\_\_\_\_

Count the number of images and write the total number in each box.  
Circle the box with more images in each row.

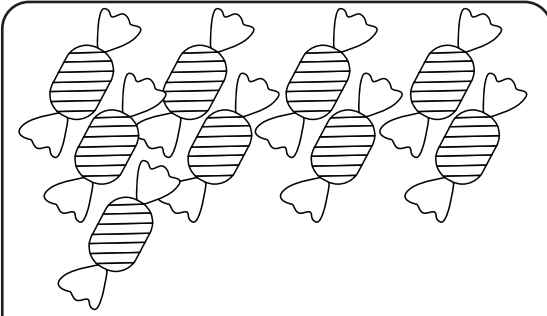

Total Number: \_\_\_\_\_

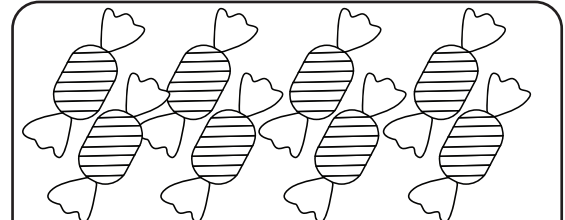

Total Number: \_\_\_\_\_

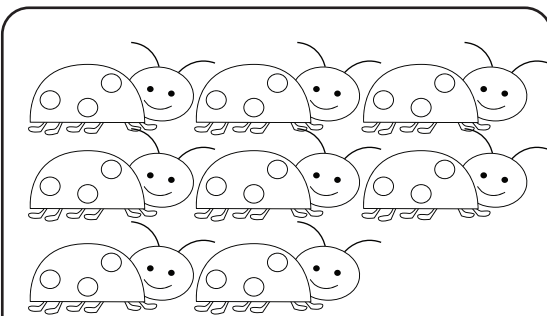

Total Number: \_\_\_\_\_

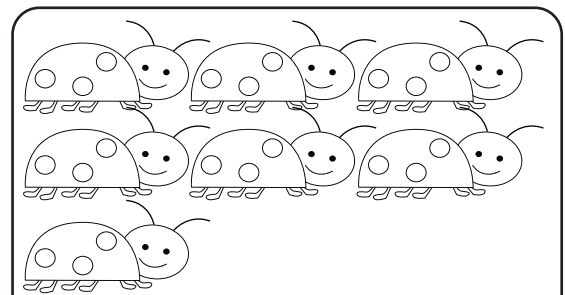

Total Number: \_\_\_\_\_

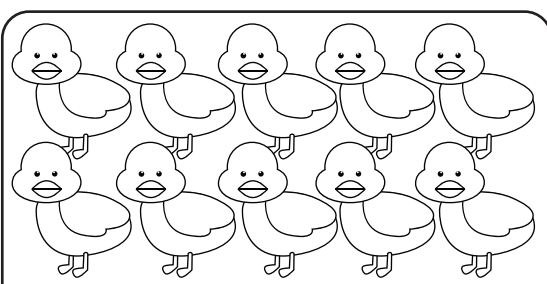

Total Number: \_\_\_\_\_

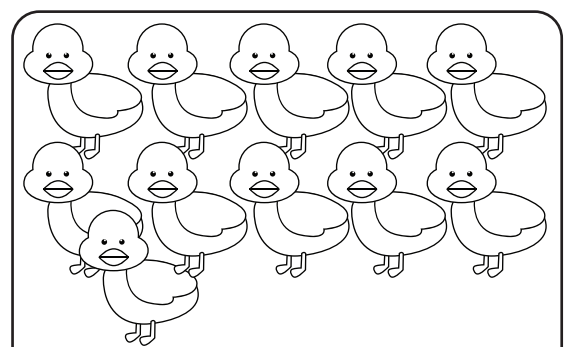

Total Number: \_\_\_\_\_

# More or Less

Name \_\_\_\_\_

Count the number of images and write the total number in each box.  
Circle the box with more images in each row.

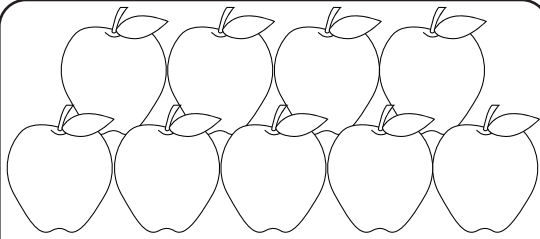

Total Number: \_\_\_\_\_

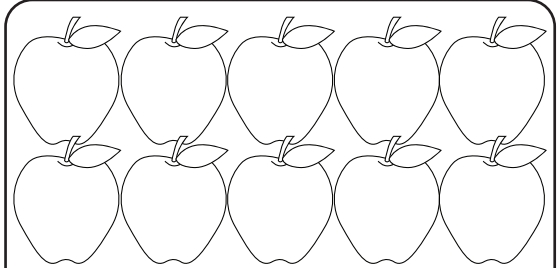

Total Number: \_\_\_\_\_

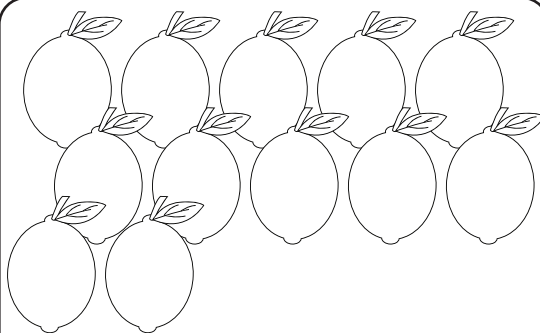

Total Number: \_\_\_\_\_

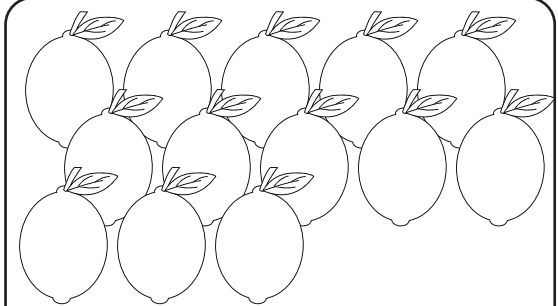

Total Number: \_\_\_\_\_

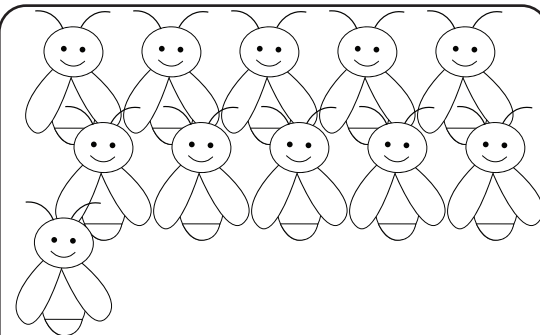

Total Number: \_\_\_\_\_

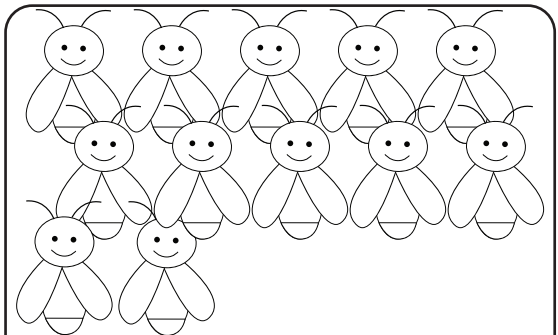

Total Number: \_\_\_\_\_

# More or Less

Name \_\_\_\_\_

Count the number of images and write the total number in each box.  
Circle the box with more images in each row.

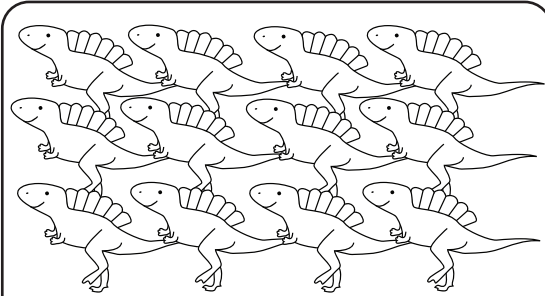

Total Number: \_\_\_\_\_

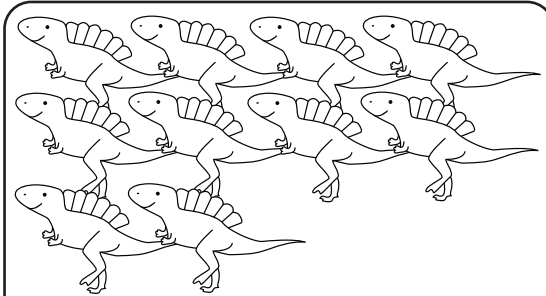

Total Number: \_\_\_\_\_

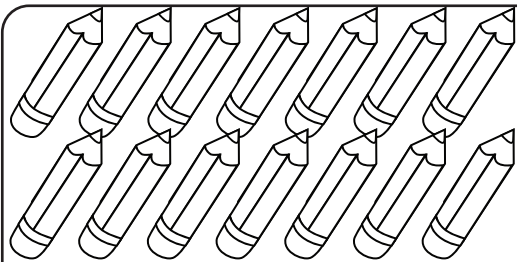

Total Number: \_\_\_\_\_

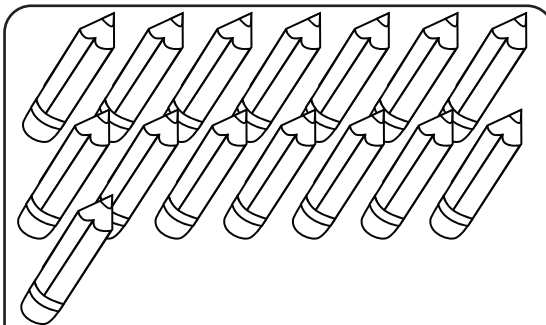

Total Number: \_\_\_\_\_

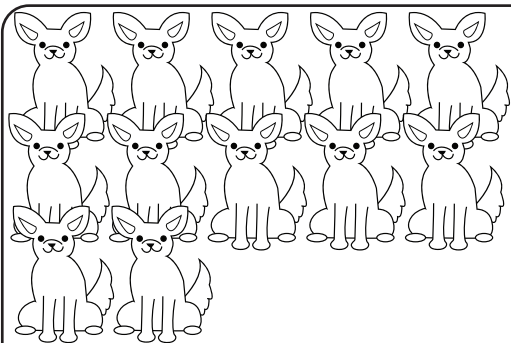

Total Number: \_\_\_\_\_

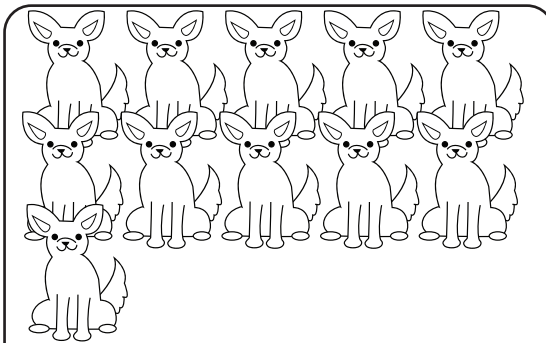

Total Number: \_\_\_\_\_

# More or Less

Name \_\_\_\_\_

Count the number of images and write the total number in each box.  
Circle the box with more images in each row.

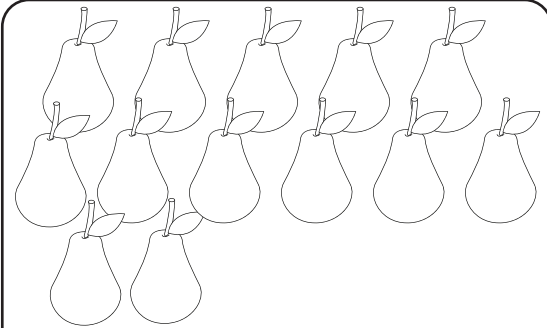

Total Number: \_\_\_\_\_

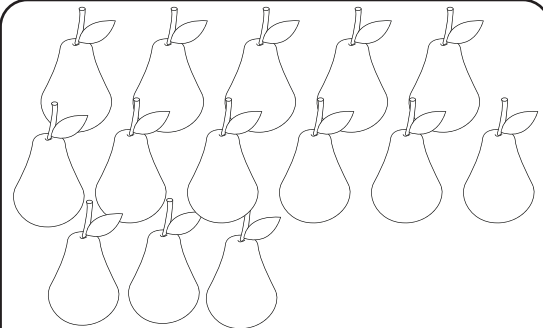

Total Number: \_\_\_\_\_

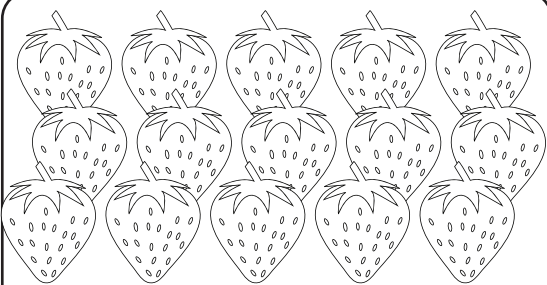

Total Number: \_\_\_\_\_

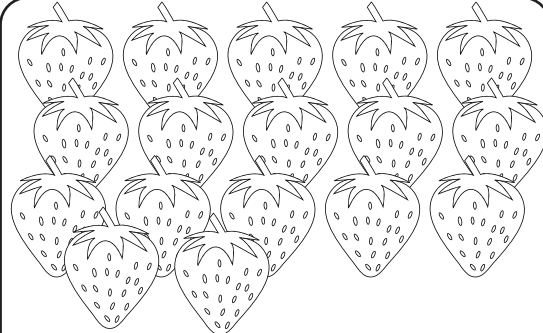

Total Number: \_\_\_\_\_

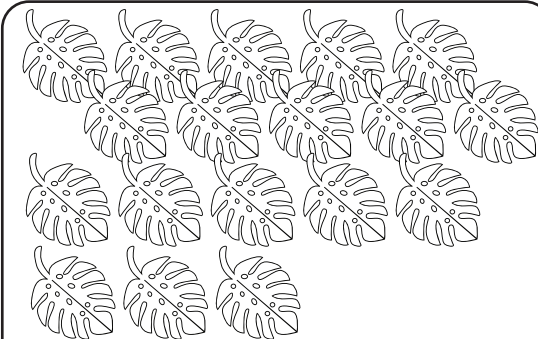

Total Number: \_\_\_\_\_

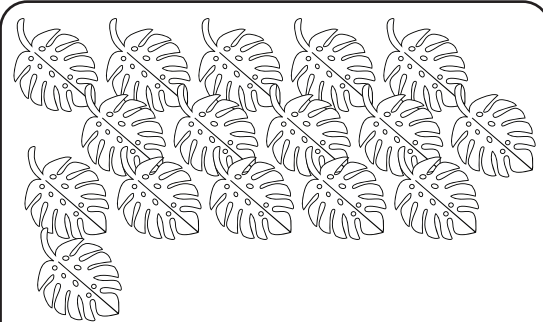





Total Number: \_\_\_\_\_



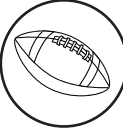
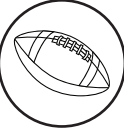
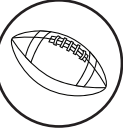
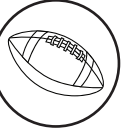
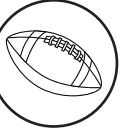
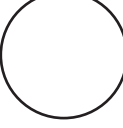
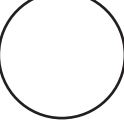
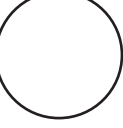
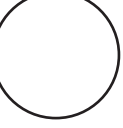
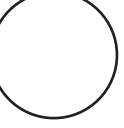

# Making 10

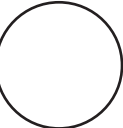
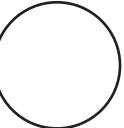
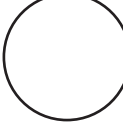
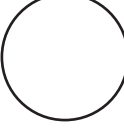
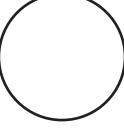
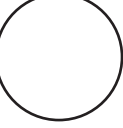
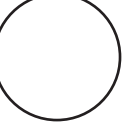

Name \_\_\_\_\_



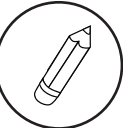

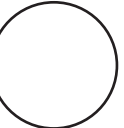
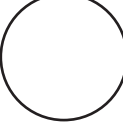
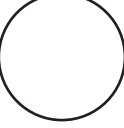
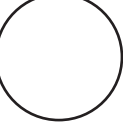
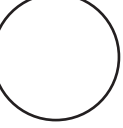
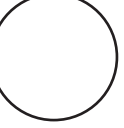

Color the empty circles and write the number that makes 10 in each box.

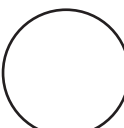
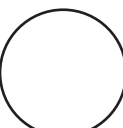
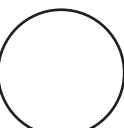
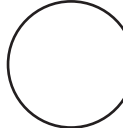
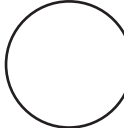
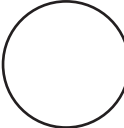
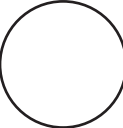
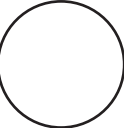



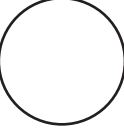
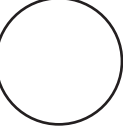
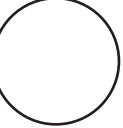
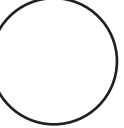

				
				
$5 + \underline{\hspace{2cm}} = 10$				

				
				
$3 + \underline{\hspace{2cm}} = 10$				

				
				
$4 + \underline{\hspace{2cm}} = 10$				

				
				
$2 + \underline{\hspace{2cm}} = 10$				

				
				
$6 + \underline{\hspace{2cm}} = 10$				

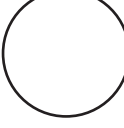
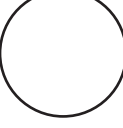
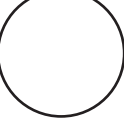
				
				
$7 + \underline{\hspace{2cm}} = 10$				

# Making 10

Name \_\_\_\_\_

Color the empty circles and write the number that makes 10 in each box.

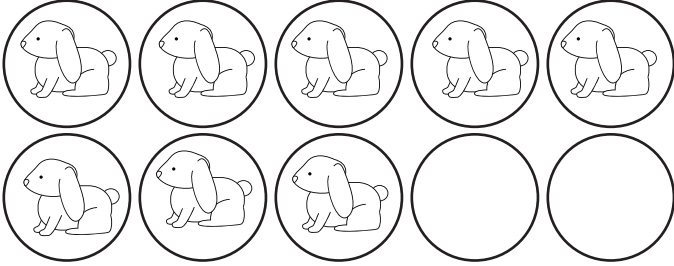

8 + \_\_\_\_\_ = 10

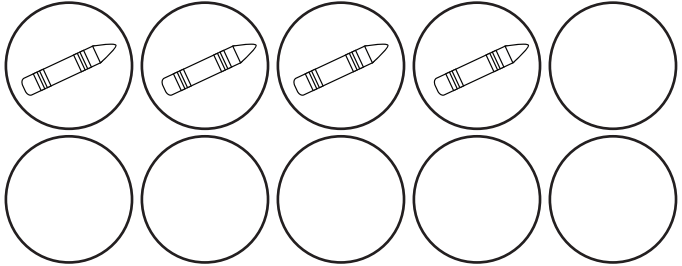

4 + \_\_\_\_\_ = 10

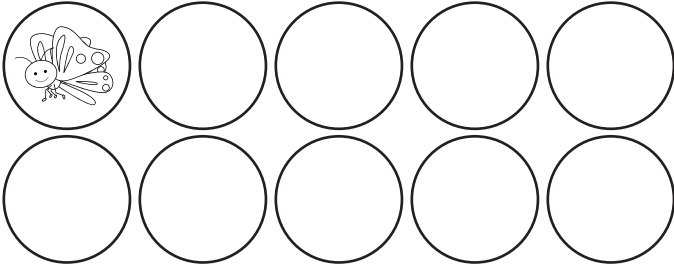

1 + \_\_\_\_\_ = 10

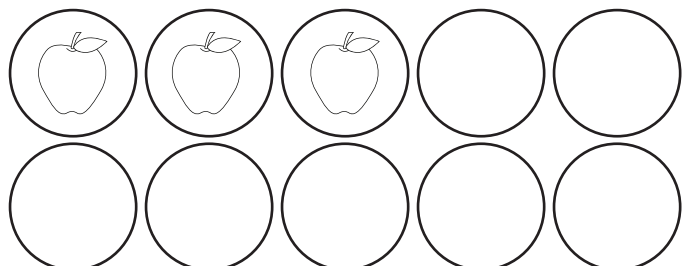

3 + \_\_\_\_\_ = 10

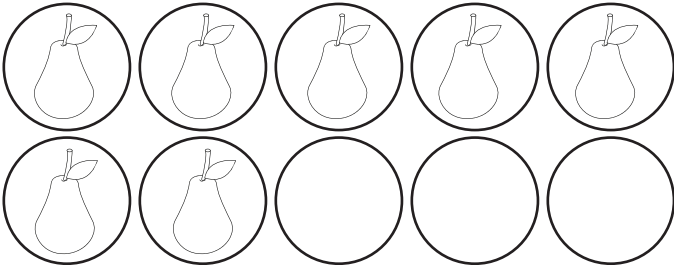

7 + \_\_\_\_\_ = 10

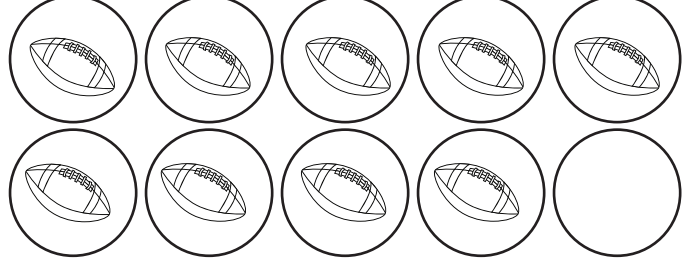

9 + \_\_\_\_\_ = 10

# Patterns

Name \_\_\_\_\_

Look at the patterns below. Cut out the images and paste the image that comes last in each box.

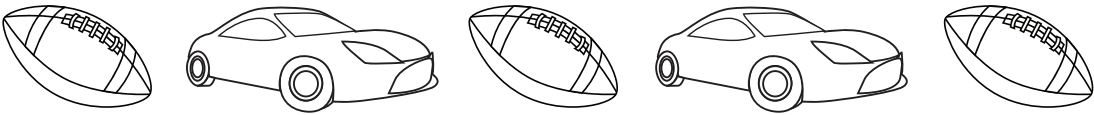

	paste here
--	------------

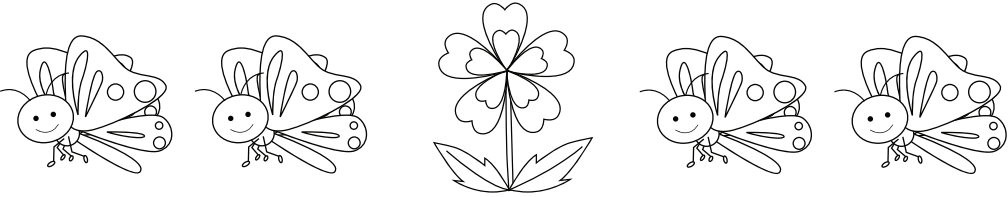
	paste here
--	------------

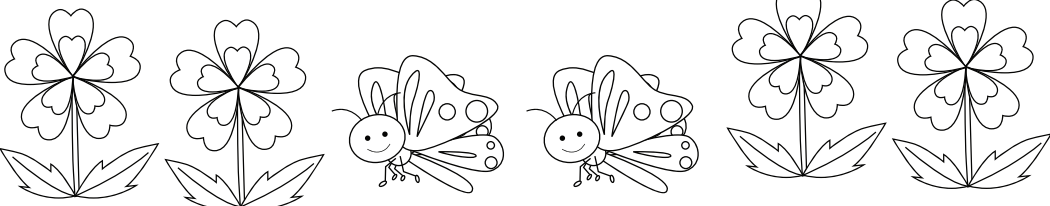
	paste here
--	------------

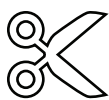
	paste here
--	------------

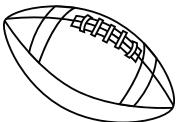

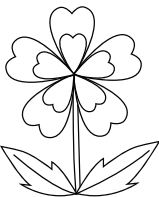
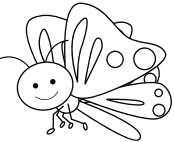
			
---	---	--	---

# Patterns

Name \_\_\_\_\_

Look at the patterns below. Cut out the images and paste the image that comes last in each box.

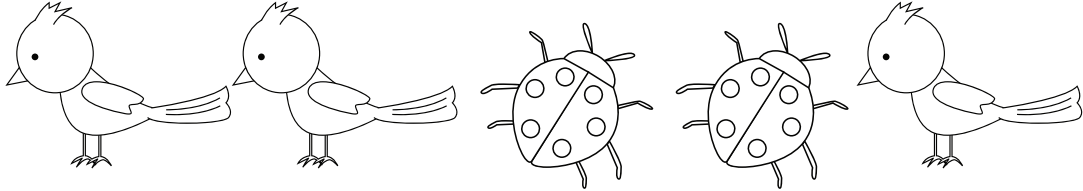
	<p>paste here</p>
--	-------------------

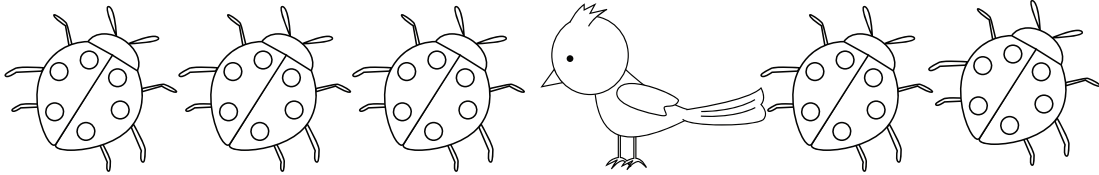
	<p>paste here</p>
--	-------------------

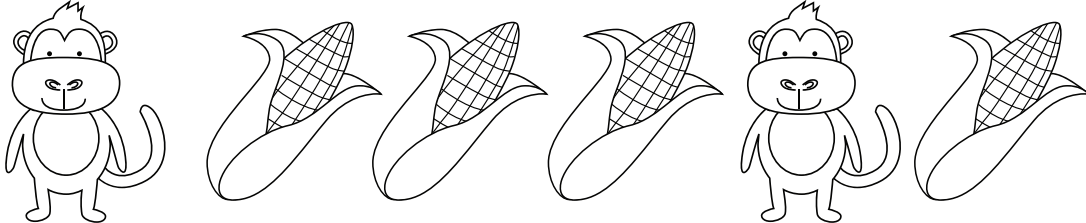
	<p>paste here</p>
--	-------------------

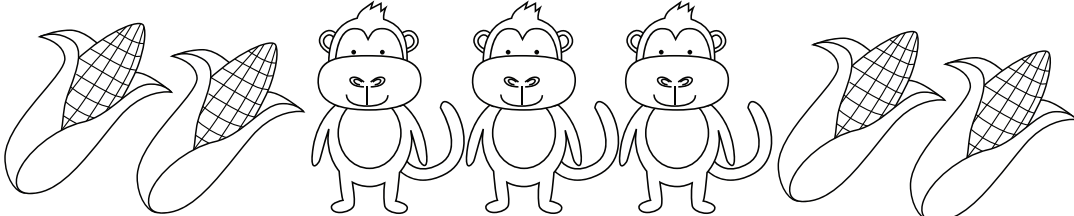
	<p>paste here</p>
--	-------------------

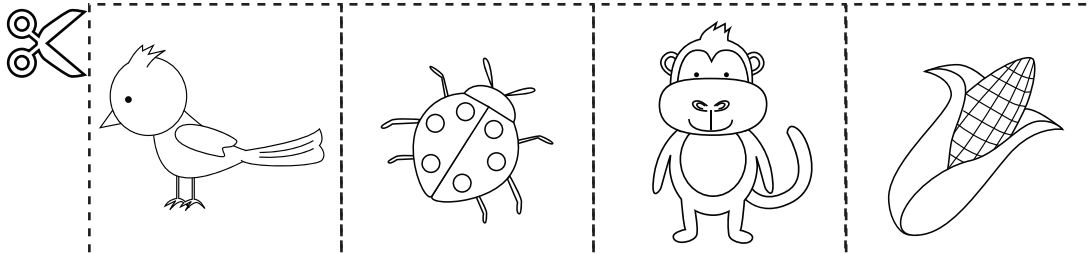

# Patterns

Name \_\_\_\_\_

Look at the patterns below. Cut out the images and paste the image that comes last in each box.

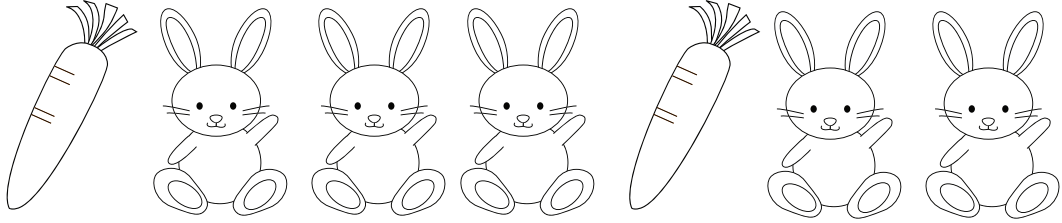
	<p>paste here</p>
--	-------------------

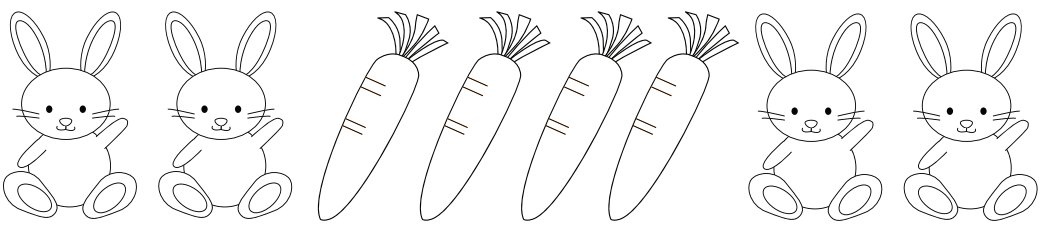
	<p>paste here</p>
---	-------------------

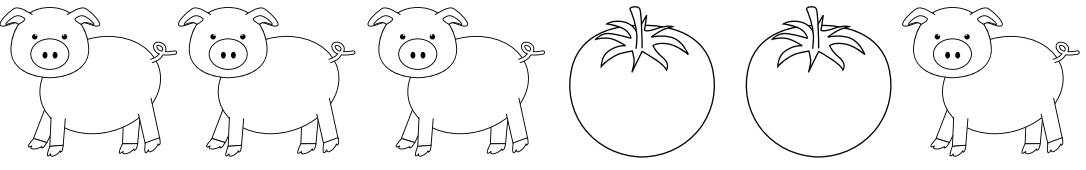
	<p>paste here</p>
--	-------------------

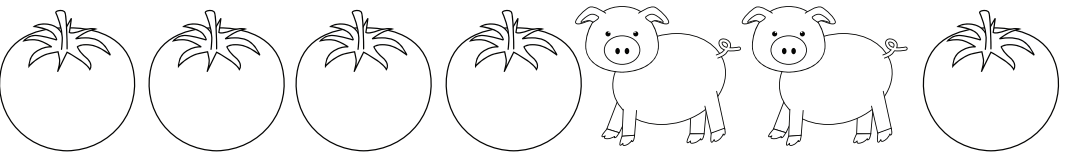
	<p>paste here</p>
--	-------------------

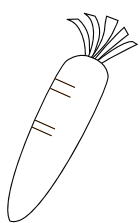
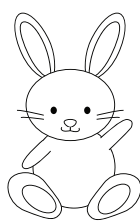
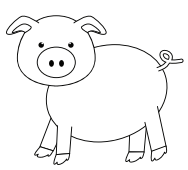
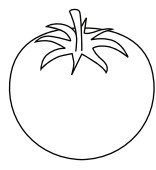

			
---	---	--	---

# Patterns

Name \_\_\_\_\_

Look at the patterns below. Cut out the images and paste the image that comes last in each box.

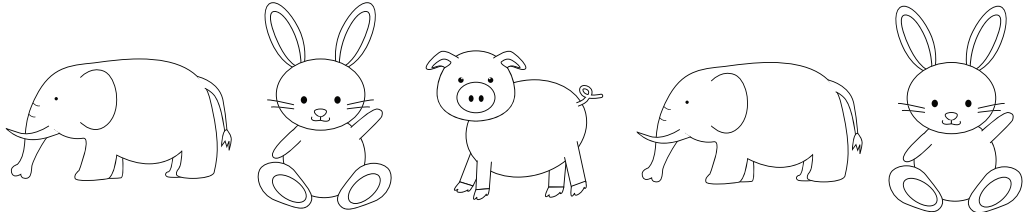
	<p>paste here</p>
--	-------------------

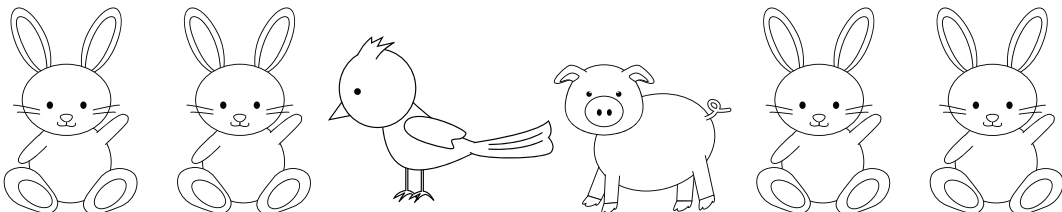
	<p>paste here</p>
--	-------------------

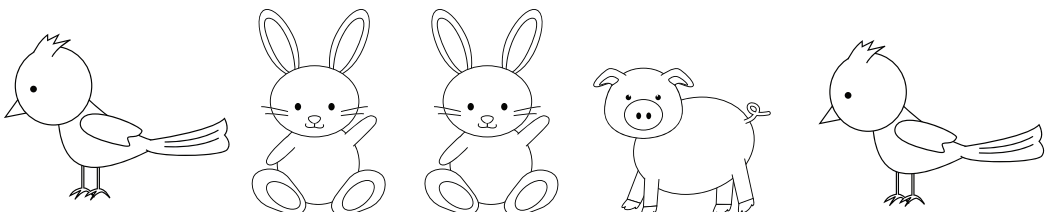
	<p>paste here</p>
--	-------------------

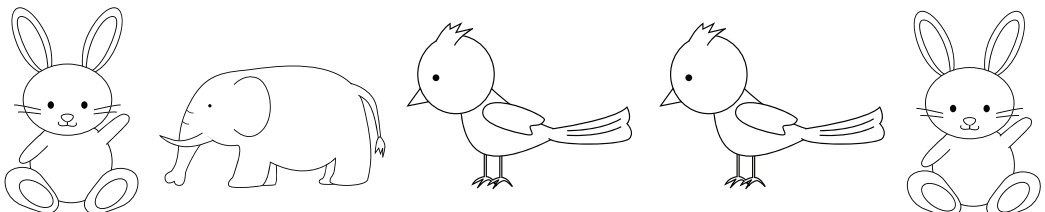
	<p>paste here</p>
--	-------------------

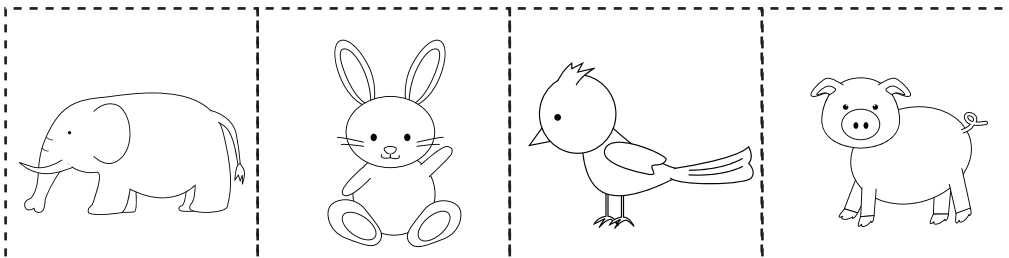

# Patterns

Name \_\_\_\_\_

Color the images to make the patterns.

AB

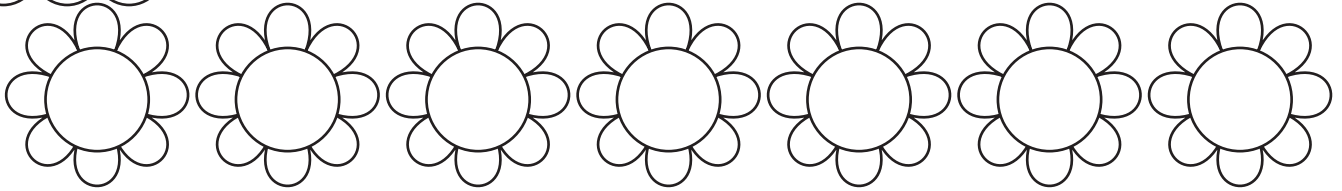

AAB

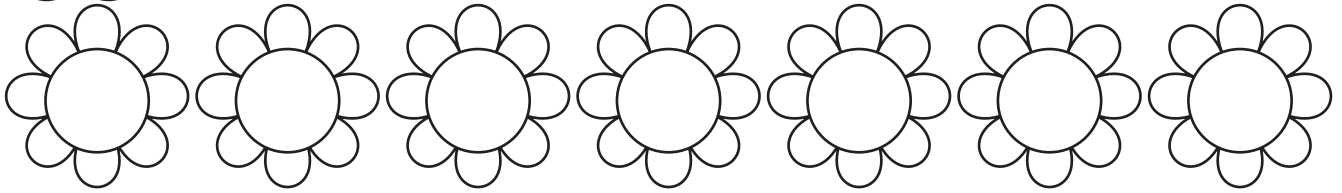

AAAB

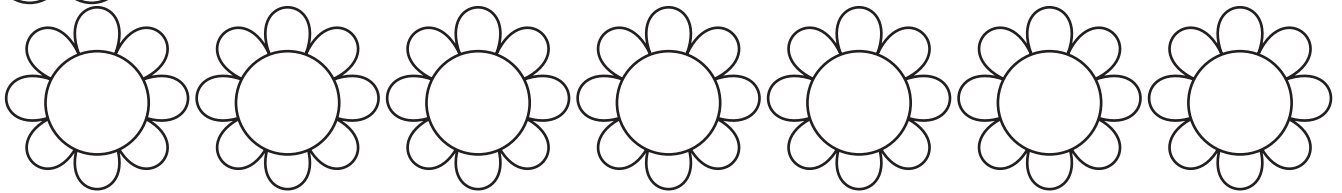

AABB

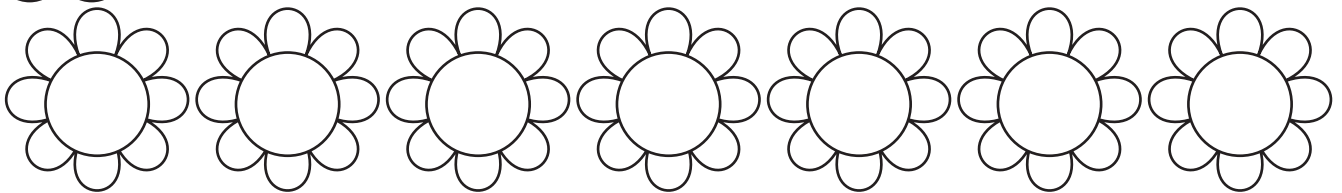

ABBB

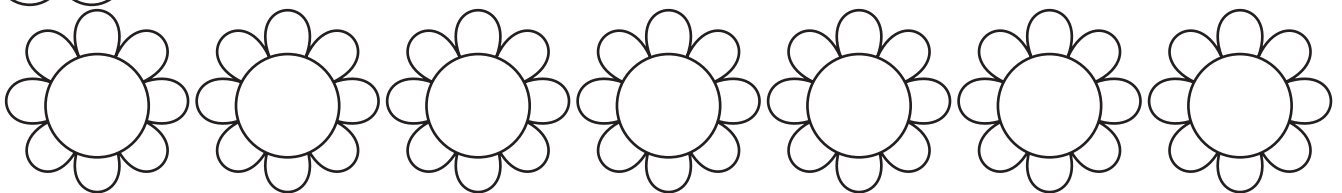

# Patterns

Name \_\_\_\_\_

Color the images to make the patterns.

ABC



AABC



ABBC



ABCC

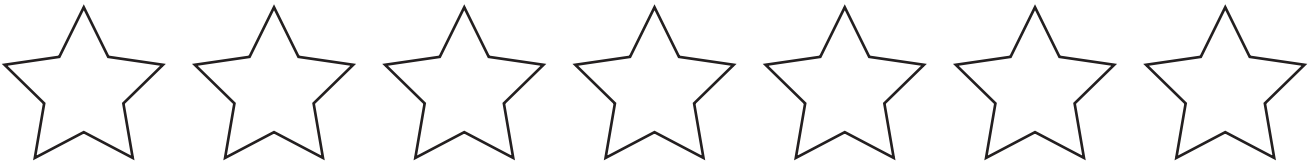

ABA



# Geometry - Circle

Name \_\_\_\_\_

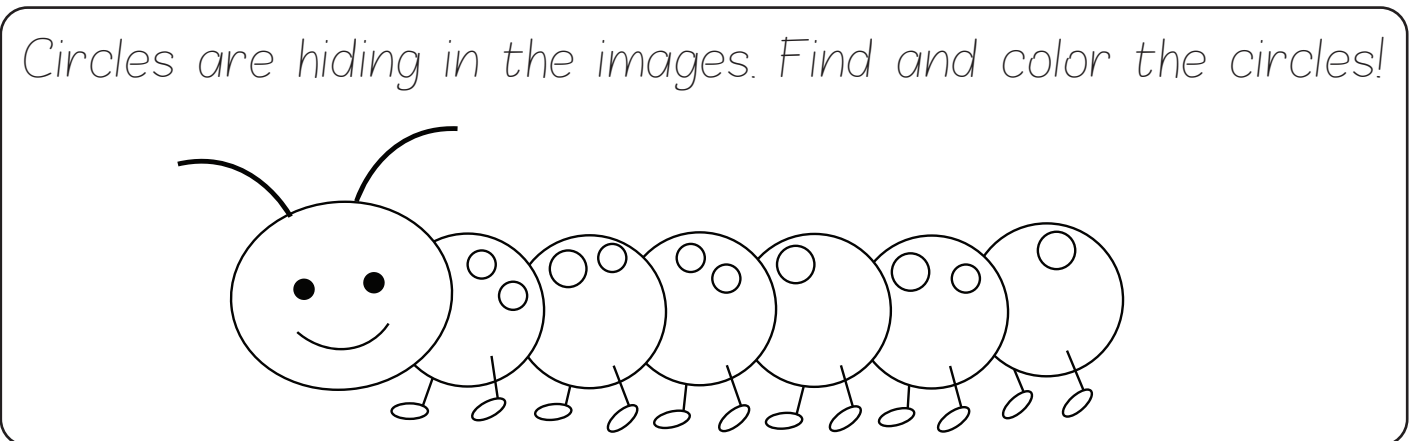
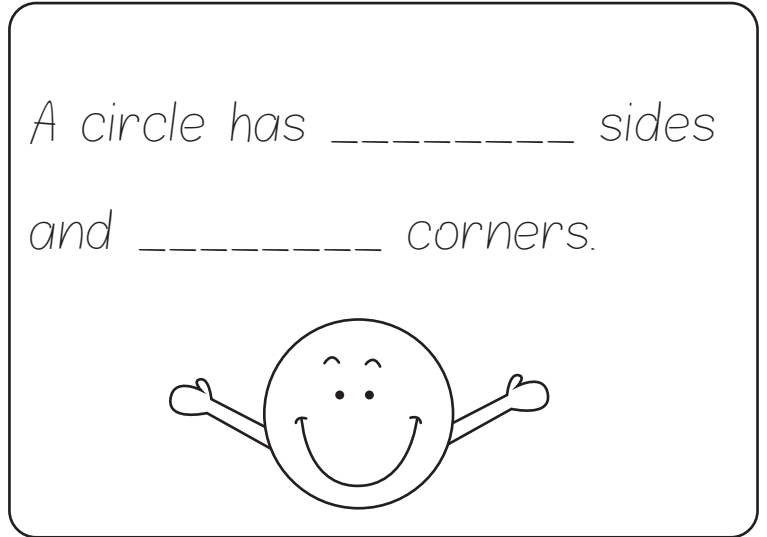
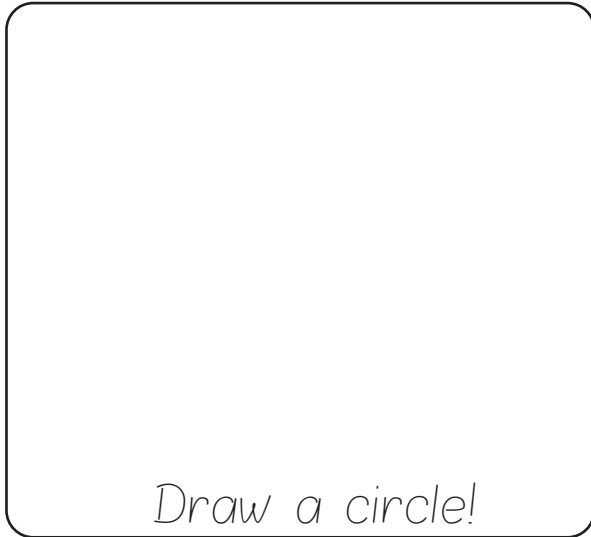
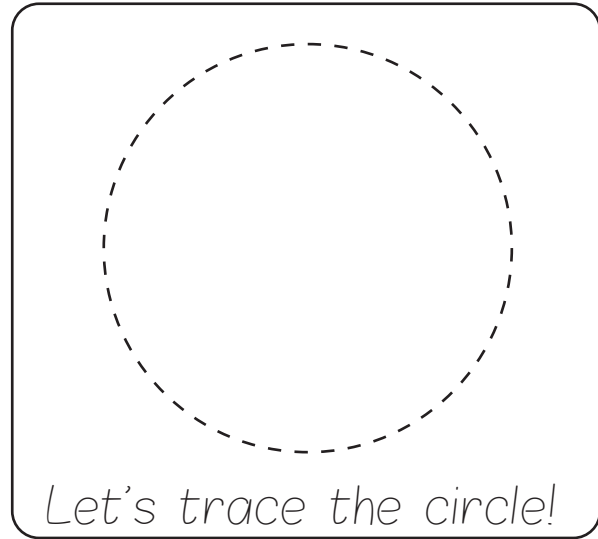
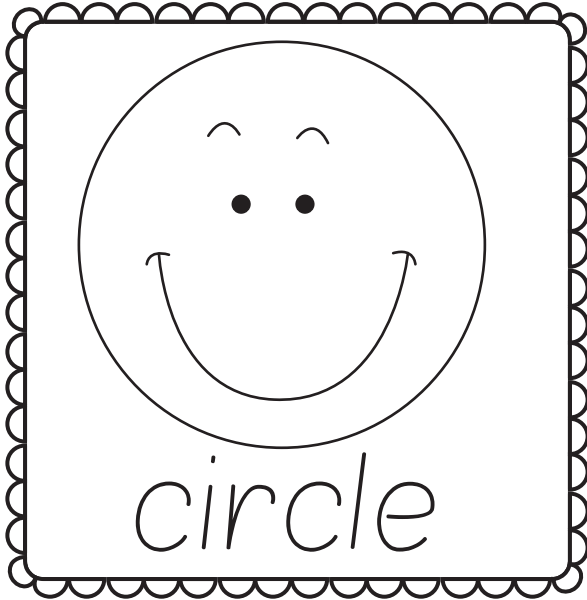

# Geometry - Triangle

Name \_\_\_\_\_

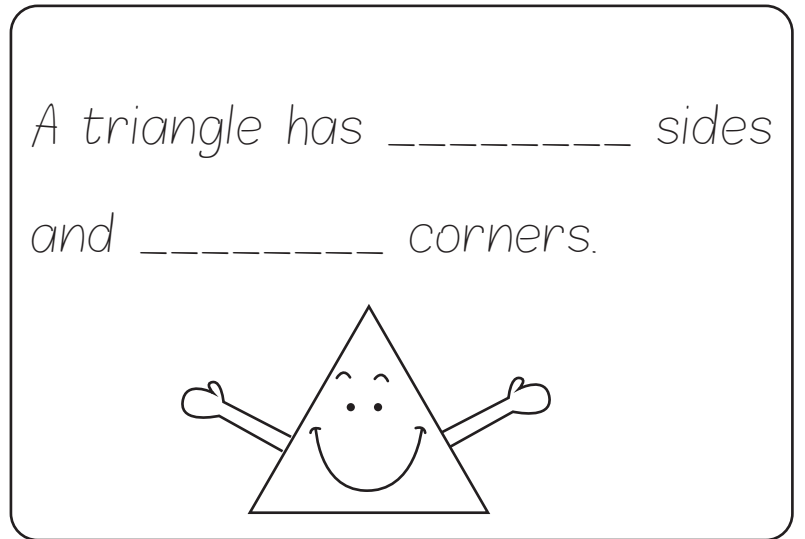
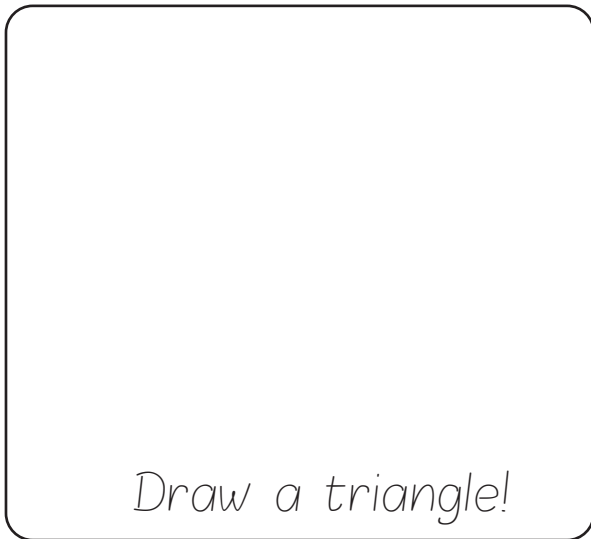
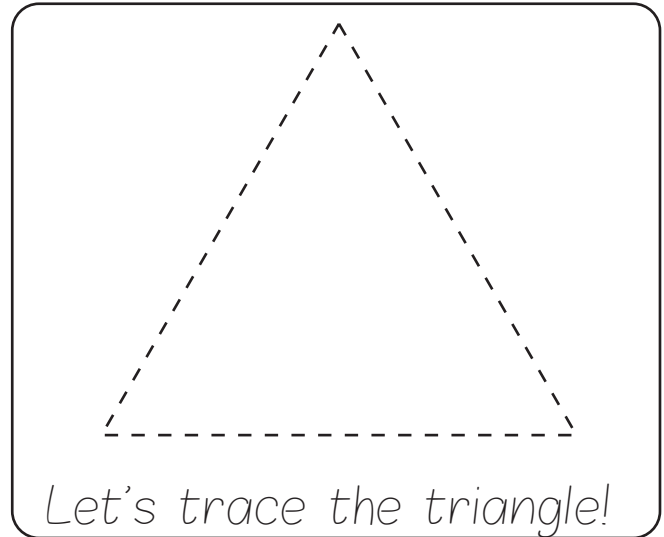
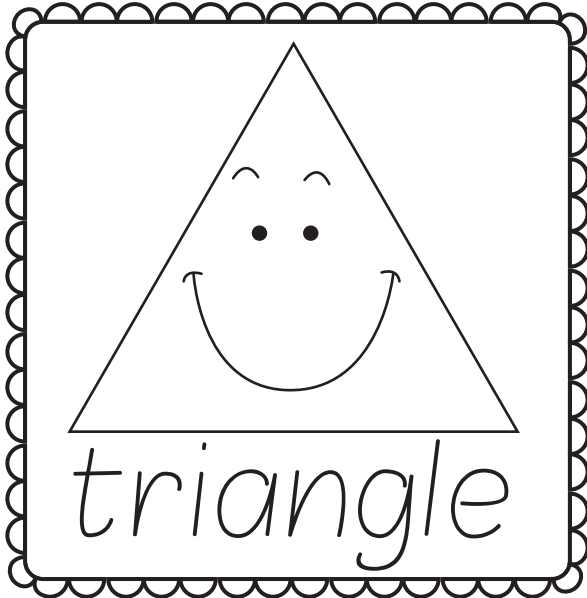

Triangles are hiding in the images. Find and color the triangles!

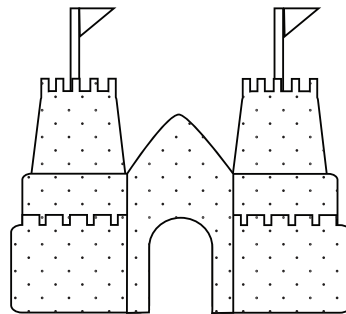

# Geometry - Rectangle

Name \_\_\_\_\_

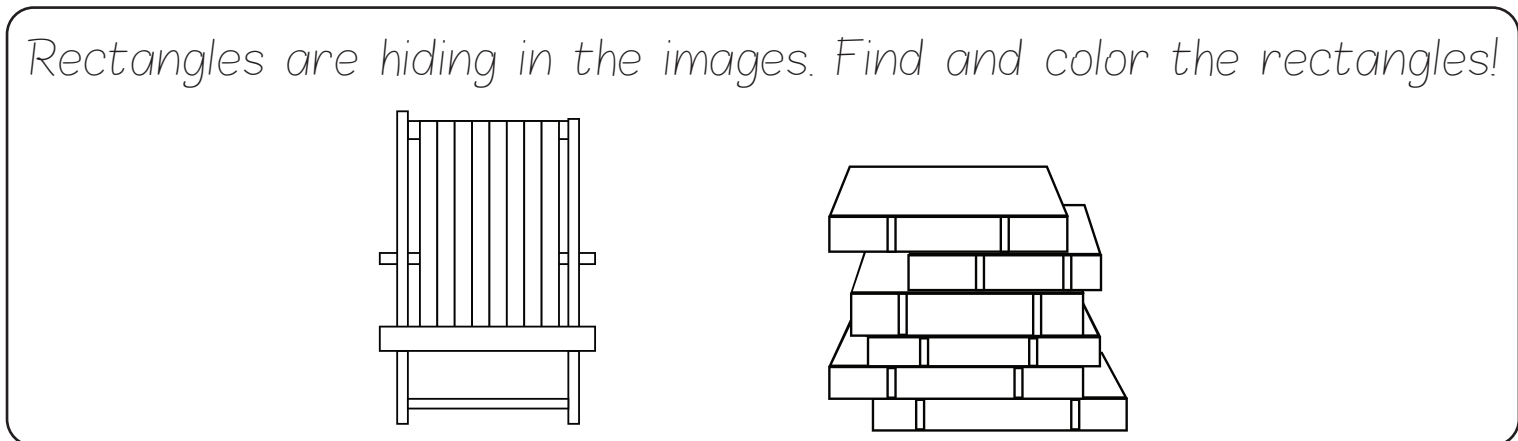
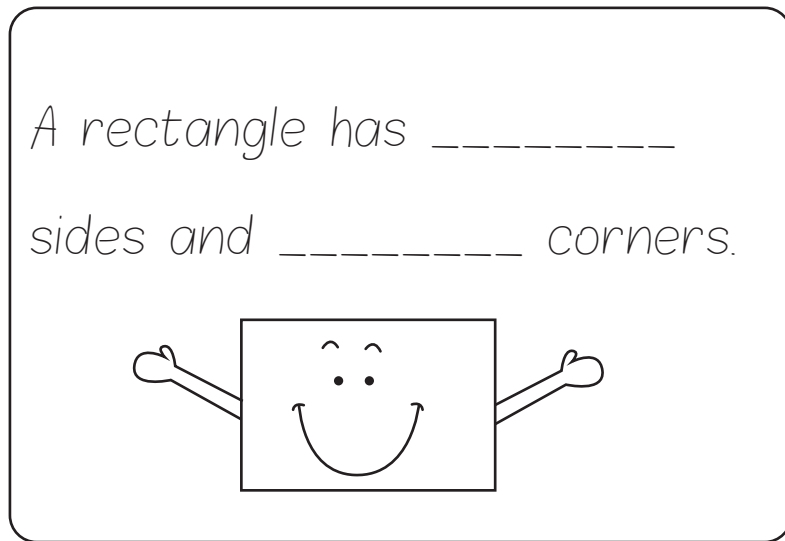
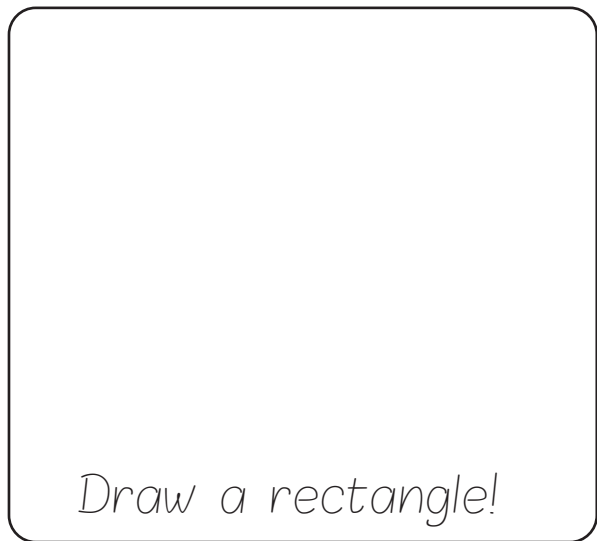
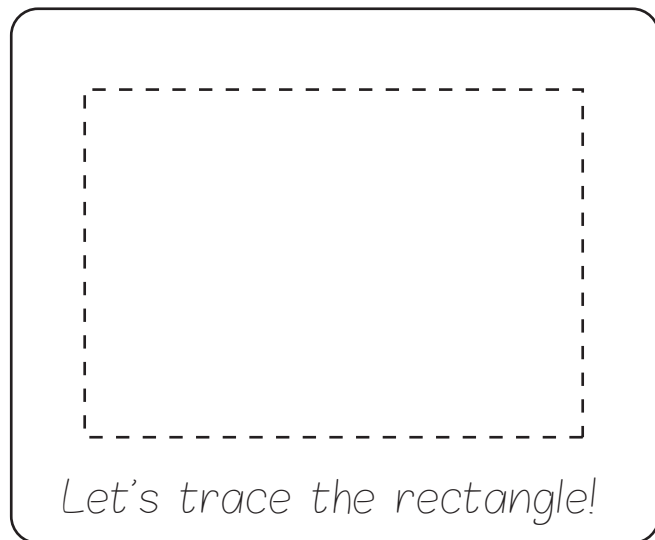
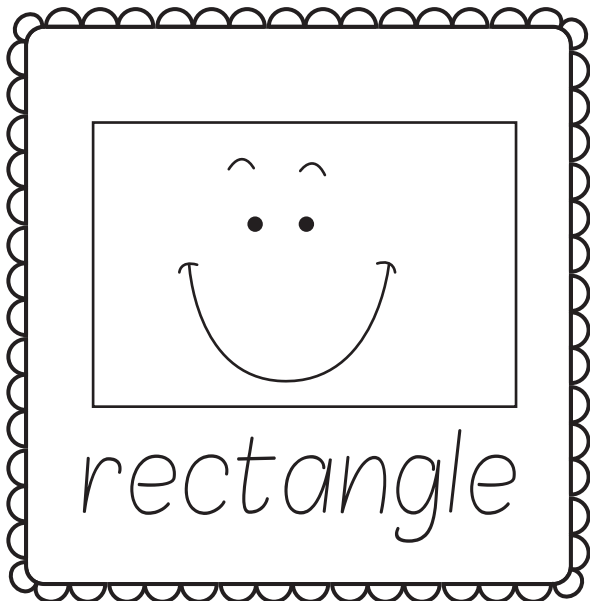

# Geometry - Square

Name \_\_\_\_\_

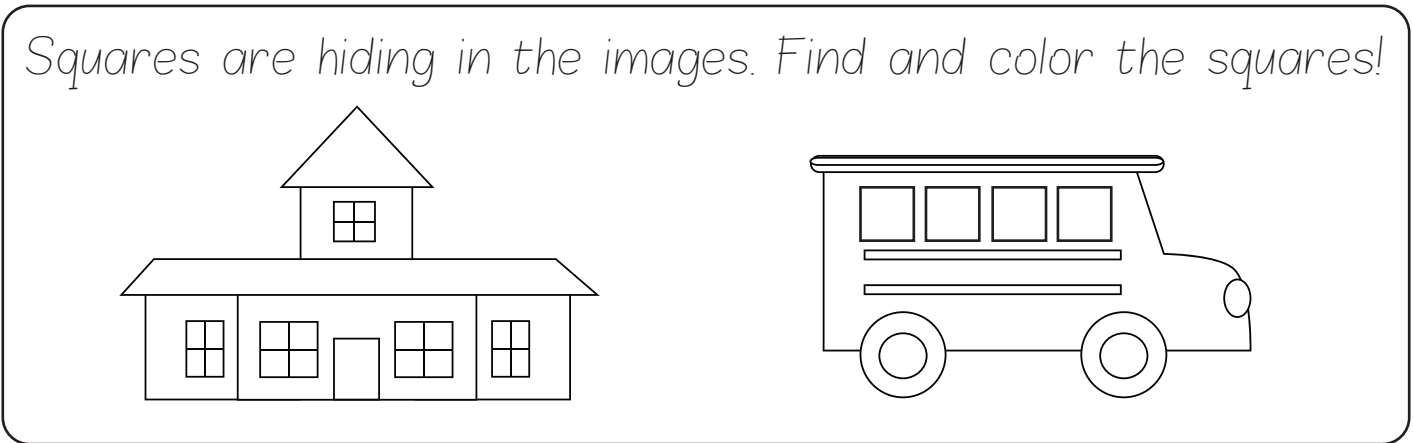
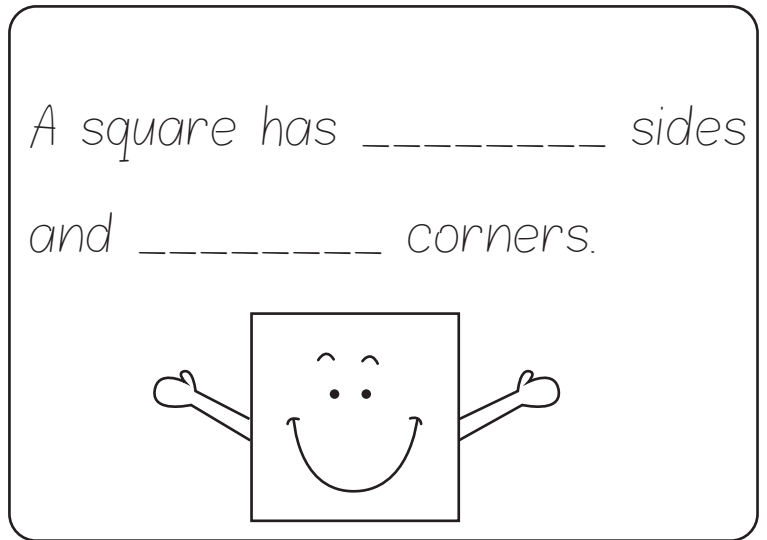
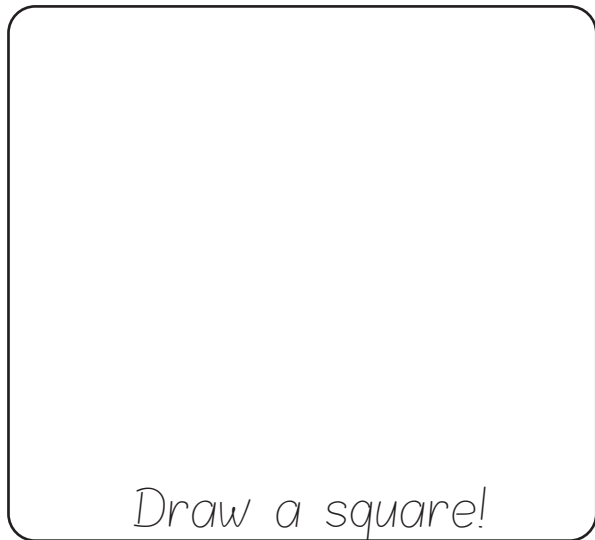
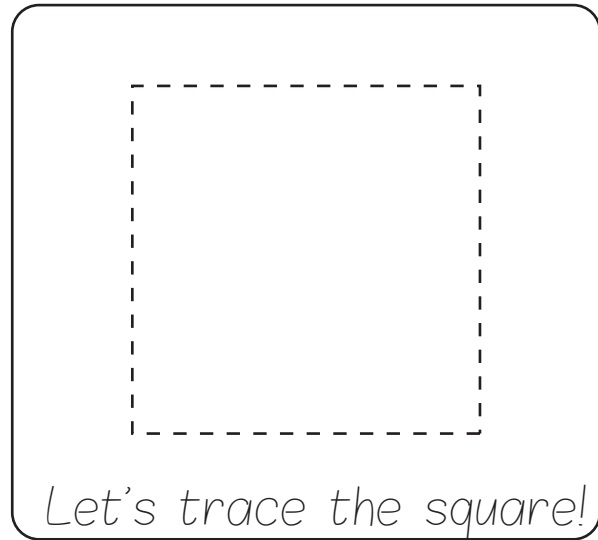
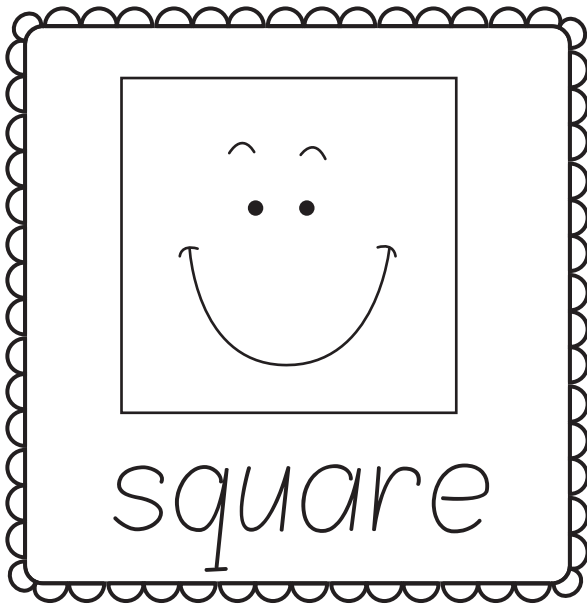

# Geometry - Trapezoid

Name \_\_\_\_\_

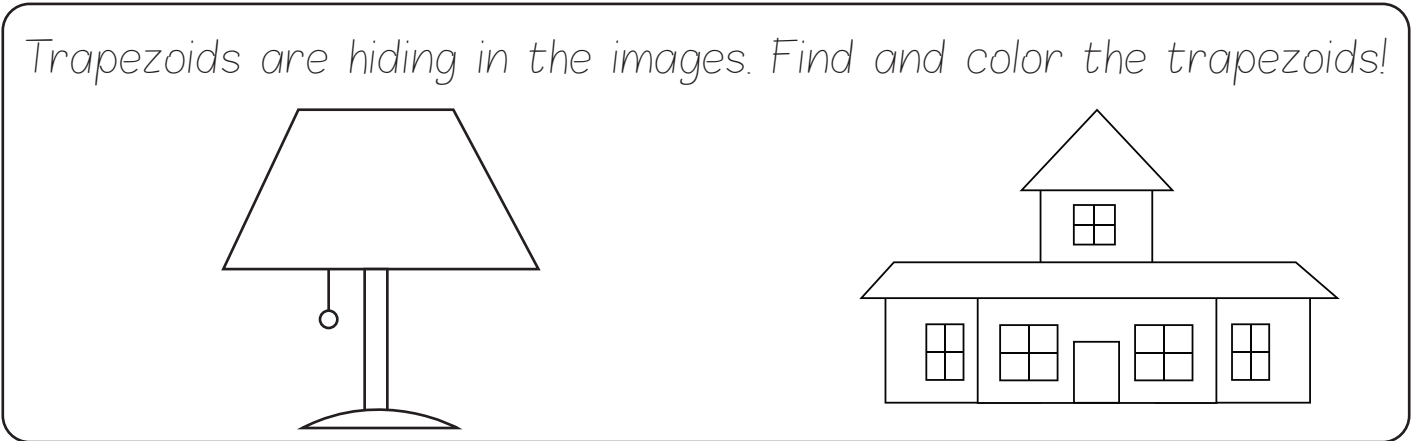
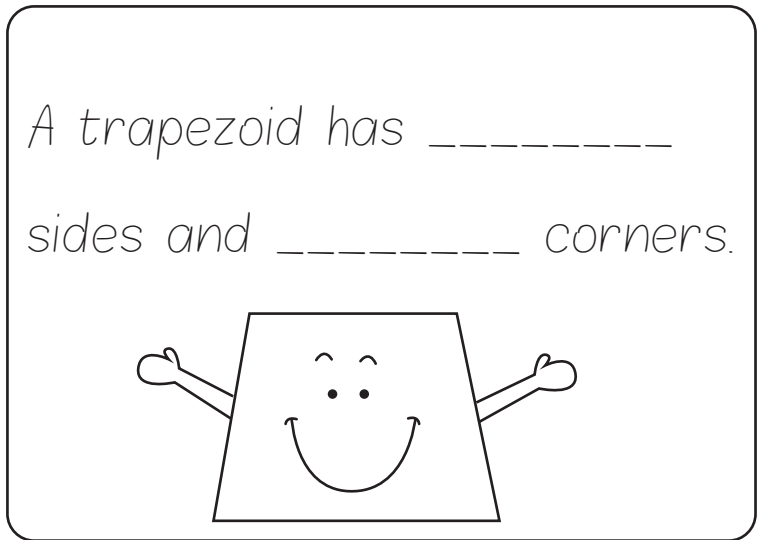
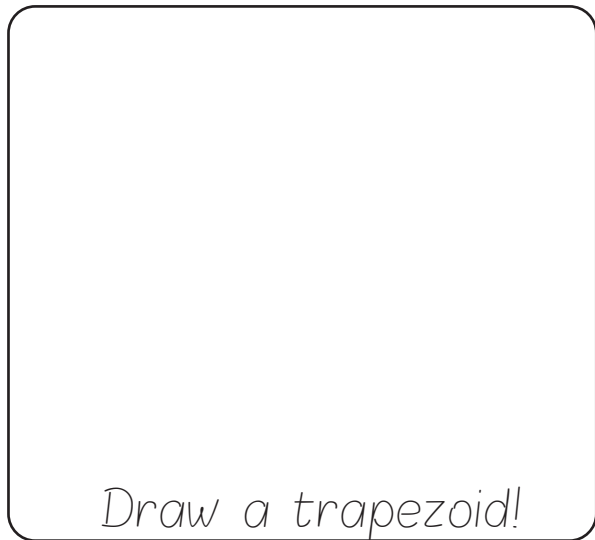
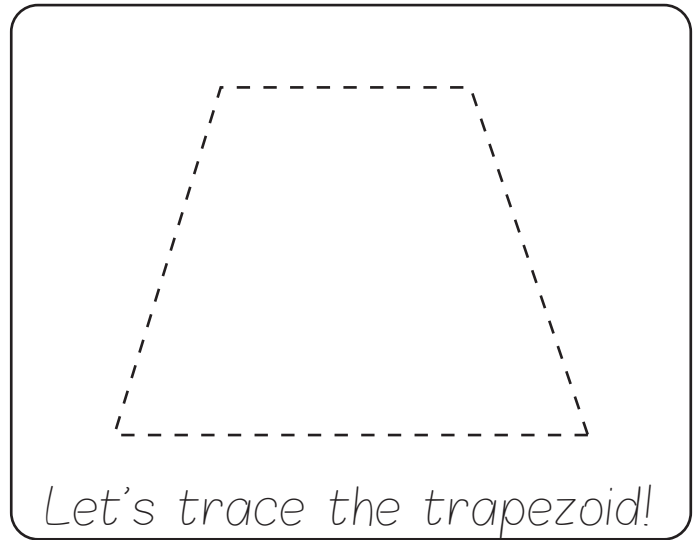
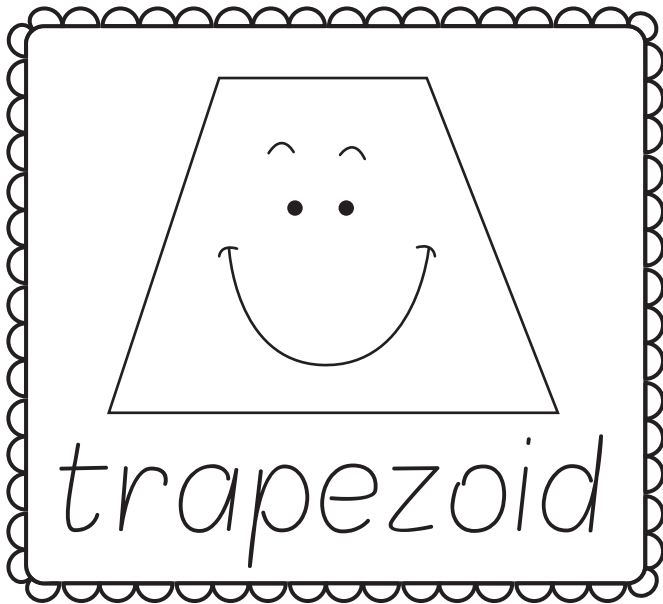

# Geometry - Hexagon

Name \_\_\_\_\_

